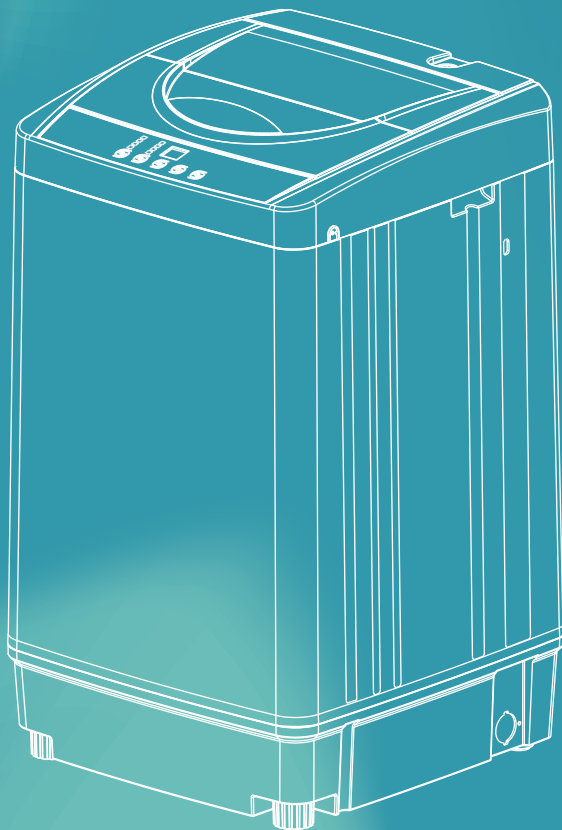


SKU: PCW002-159WH-USZX

Model: FW50-1518L

WASHING MACHINE

Instruction Manual



Congratulations on purchasing your new product. To ensure proper operation, please read this instruction manual carefully before using this product. Keep this manual in a safe place for future reference.



Email:
support@homyd.com

Call: 1-833-632-0897

Working hours: Mons to Fris,
8 AM - 4 PM (PT)-632-0897

Congratulations

Dear Customer:

Welcome to the our family. Thank you for purchasing one of our products.

Our goal is to provide you with superior service. If there is anything missing from or wrong with your order, or if you have any questions about using our product, PLEASE contact us.

Call: 1-833-632-0897

Email: support@homyd.com

Working hours: Mons to Fris, 8 AM - 4 PM (PT)

Our team is available 24/7 to address your questions, comments, and concerns. Your satisfaction is our ultimate goal. We want to make everything right so you'll share your positive experience with other shoppers on Amazon.

If you experience any problems, please send an email to support@homyd.com.

Call: 1-833-632-0897 Working hours: Mons to Fris, 8 AM - 4 PM (PT)

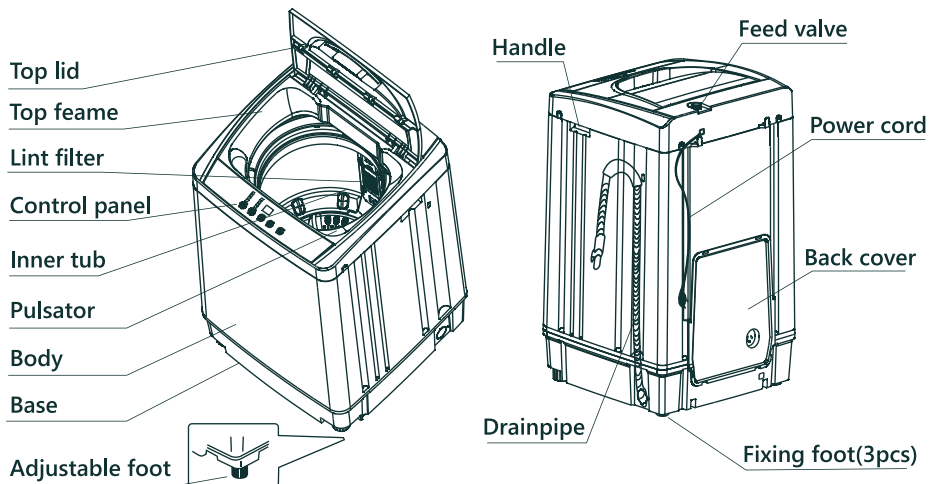
Our mission:

- * To be the most trusted appliance brand.
- * To create practical, compact appliances that better your life.


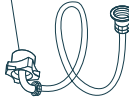

TABLE OF CONTENTS

| | |
|------------------------------|-------|
| Parts name | 2 |
| Cautions | 3-4 |
| Installation and adjustment | 5 |
| How to use drainpipe | 6 |
| Water inlet installation | 7 |
| Preparation before operation | 8 |
| Load laundries | 9 |
| Use of detergent | 10 |
| Control panel instruction | 11-12 |
| Operation steps | 13 |
| Maintenance | 14-15 |
| Troubleshooting | 16-17 |
| Other functions | 18 |
| Specifications | 19 |
| Warranty and Service | 20 |



Parts name



Accessories

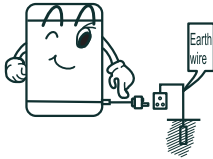
| | | |
|--|--|---|
|  | <p>The end connecting to the appliance</p>  <p>The end connecting to water inlet hose connector</p> |  |
| <p>Bottom cover (1pc)</p> | <p>Water inlet hose (1pc) water inlet hose connector(1pc)</p> | <p>Tapping screw ST4X14(2pcs)</p> |

Symbol definition

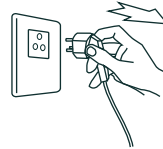
| | |
|---|---|
| <p>Warning symbols</p>  | <p>Pay special attention to the warning symbols. There may be serous risks to personal body safety or damages to the washing machine if not follow.</p> |
| <p>Forbidden symbols</p>  | <p>Please stop doing the contents with this symbol, otherwise it will damage the appliance or injure your personal body.</p> |

I Cautions

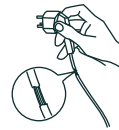
Please insert the plug into the power socket with rated voltage 220-240V AC.



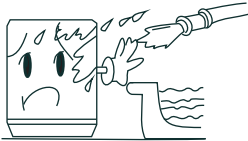
Always unplug the appliance and turn off the water when the power is cut, moving or cleaning the washing machine, or it is not in use. Do not insert or pull off the plug with wet hand.



Do not make the electric cable bended, stretched, twisted, strapped or changed, pressed or nipped. If the electric cable or plug is damaged or the socket becomes loose, they must be repaired or changed by our appointed repair stations or the professionals of our post-sale service department to avoid danger. The pin of the plug must remain clean. Please clean it carefully with dry cloth if it is dirty.



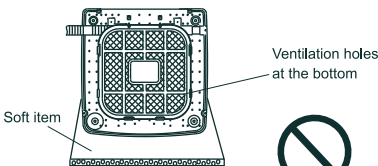
Don't install the washing machine in bathroom or damp places. Do not wash the machine with water, do not put wet clothes on the control panel film.



Do not use water hotter than 50°C.



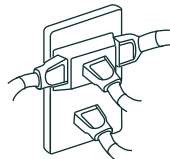
If the machine is situated on a carpeted floor, please adjust the feet in order to allow air to circulate freely.



Do not wash raincoat, bike cover, feather dress and such waterproof laundries, which will make the washing machine abnormal vibrations during spinning.



Do not share the same socket with other electric appliances. Do not use the damaged plug or loose socket.



Cautions

Do not put hands into the working machine. It is dangerous even if the speed is very slow. Take special care of the children, and forbid them to climb on the washing machine.



It is dangerous to alter the specifications or attempt to modify this product in any way.



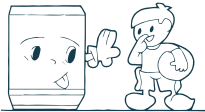
Do not overload the appliance or put any hot goods (such as the kettle with hot water) on the washing machine.



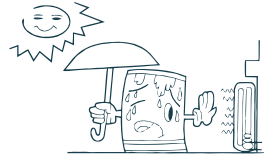
Garments which have been in contact with volatile petroleum products should not be machine washed.



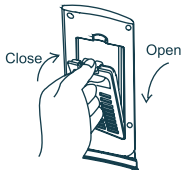
This appliance is not intended for use by persons (including children) with reduced physical, sensory or mental capabilities, or lack of experience and knowledge, unless they have been given supervision or instruction concerning use of the appliance by a person responsible for their safety. Children should be supervised to ensure that they do not play with the appliance.



Keep the appliance away from direct sunlight and heat sources like the heater.



To prevent the lint from blocking cascade outlet during washing, please keep the lint filter in good condition, install it to proper position and clean it in time.



Any objects such as coins, safety pins, nails, screws, stones or any other hard, sharp material can cause extensive damage and must not be placed into the machine.



- Before washing, please ensure the tap is open and the inlet hose is installed properly.
- It is suggested to use low foam washing powder.

I Installation and adjustment

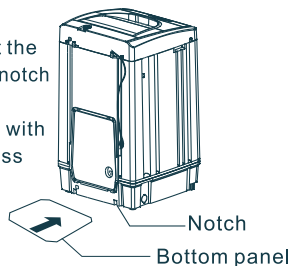
Please install and adjust the machine according to the requirements of the manual. It is very important to your safety and correct operation.

Unpacking

- Unpack the carton and take out the bottom panel.
- Open the top lid of washing machine and take out all of the accessories.
- Remove all wrappers, including the polystyrene base.
You are advised to keep all the packaging for reuse in case the machine is to be transported again.

Installing the bottom cover

- Please lean the machine forward gently, and insert the bottom cover (the side with instructions) into the notch along arrowhead direction.
- Fix the bottom cover on the washing machine base with two tapping screws in the accessories by using cross screwdriver.

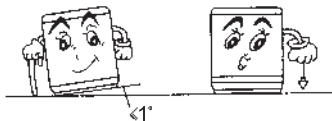


Positioning

The distance between the washing machine and the wall should be more than 50mm, and the maximum allowed angle of the shank base of the machine is 1°. The slanting or rough ground may cause operating stopped or unstable, please adjust it with the following methods:

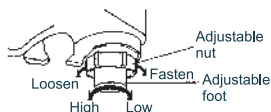
- Make it horizontal

Use a tied thread with plumb to check if it is horizontal.

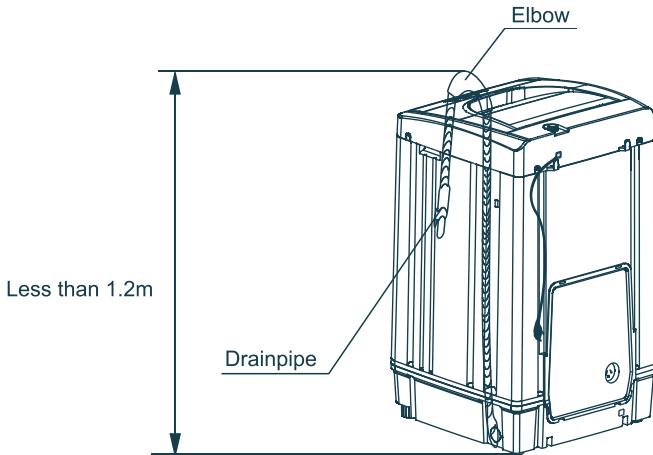


- Adjust the adjustable foot

- 1、Lift up the adjustable foot gently, loose the adjustable nut and twist the adjustable foot.
- 2、Fasten the nut after adjustment.



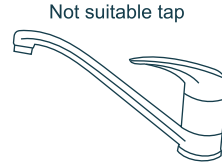
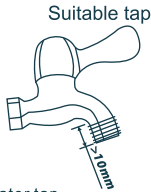
I How to use drainpipe



1. The drainpipe could be hanged or put down during use, If drainpipe is hanged during use, the height must less than 1.2m .
2. You can adjust the situation of the elbow bend pipe to change the height of the drainpipe.
3. Do not extrude the drainpipe to ensue drain smoothly.

I Water inlet installation

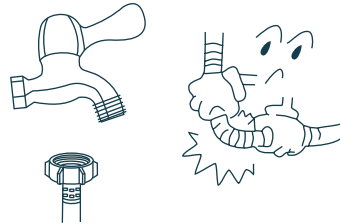
Tap selection



- Use new Water tap
- The front end should be longer than 10mm. The tap exit end face should be flat and smooth, if not file it to avoid leakage

Check the connection between inlet hose connector and the tap

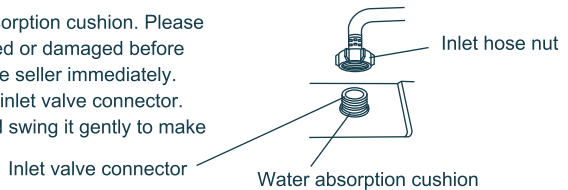
1. Swing the inlet hose gently to confirm if it is fastened.
2. After installation, open the tap and check if it leaks.
3. Do not bend the inlet hose with overstrain.
4. Before each usage, check the connection between inlet hose connector and the tap. Make sure they are firmly fitted to prevent dropping from improper installation position.



- The instruction for appliances connected to the water mains by detachable hose-sets supplied with the appliance are to be used and that old hose-sets should not be reused.

Connect the inlet hose with the washing machine

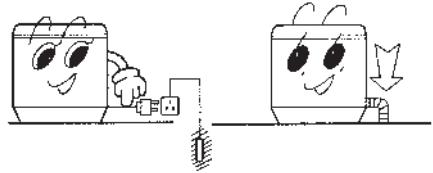
1. Do not take off the water absorption cushion. Please check if the cushion is dropped or damaged before each usage. If it is, contact the seller immediately.
2. Put the inlet hose nut on the inlet valve connector.
3. Fasten the inlet hose nut and swing it gently to make sure if it is suitable.



I Preparation before operation

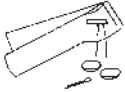



Preparation before washing

1. Connect the inlet hose and open the tap.
2. This appliance must be earthed. Confirm the socket is earthed reliably and insert the power plug. The earth terminal should not link to gas pipeline, tap pipeline etc.
3. Put down the drainpipe.



Warning: the temperature of the water should less than 50°C !

Before washing the laundries, please pay attention to the followings:

| | | | | |
|---|--|--|---|---|
| <p>Make sure if there is special requirements for the laundries</p> | <p>Before washing, empty all pockets of small objects which may have been left inside (coins, keys, screws etc.) As these could damage the drain pump.</p>  | <p>Knot the long band, fasten the buttons and close the zippers.</p>  | <p>Do not overload the machine. Load the laundry loosely alternating large items with small ones.</p>  | <p>Sort the laundry according to the type of fabric, color-fastness and how dirty it is. Put thin laundries, woolsens and such prone to wear and tear laundries into washing bag.</p>  |
|---|--|--|---|---|

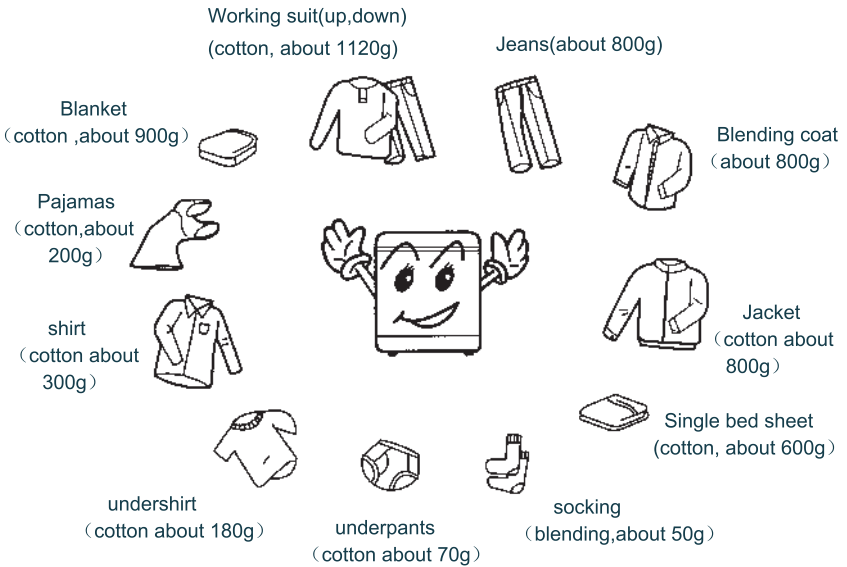
- A. Make sure the laundries are washable.
- B. It is essential to wash new colored items separately when washing for the first time. White items should not be washed with colored items.
- C. Please immerse the non-absorbable laundries by hand.
- D. Some stains such as fruit, wine, grass, rust etc. are difficult to remove and should be treated before washing with specific products, which can be found in most household shops. In some cases it may help to soak the stain before washing with a special pre-soak product or biological detergent.
- E. Overturn the nap fabric and long floss laundries before putting them into the machine.
- F. Do not put the laundries polluted by chemicals into the machine directly.
- G. Very small item(handkerchiefs, ribbons, socks etc) should be washed in a washing bag or a pillow case.

I Load laundries



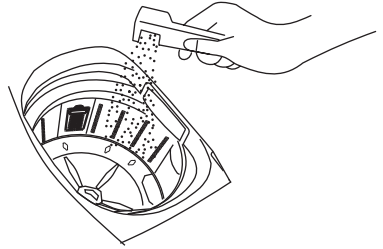
- The capacity of washing and spinning of the machine refer to the largest weight of the standard laundries under dry condition .Washing quantity shall be lower than the rated capacity.
- Different thickness, size and type of the laundries will influence the actual washing capacity. It is suitable that the laundries can be turned round normally during washing.
- Don't select high water level when laundries are less than 1.0kg to avoid water splashing.

Reference weight of the laundries



I Use of detergent

- Put the detergent powder into the tub as the right figure.
- Then colose the wash lid.
- We suggest use low sudsing detergent powder



How to use the washing powder

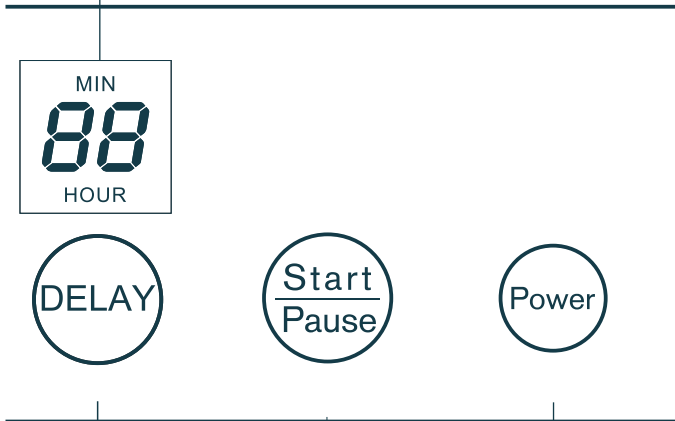
- Dissolve in the machine directly (not suitable for delay program)
 1. Low water level.
 2. Add the washing powder, and run for 30 seconds to dissolve it completely.
 3. Put laundries in, select suitable water level.
- The instant dissolving of the washing powder
 1. Prepare warm water of 30 °C in a container.
 2. Pour the powder while stirring to fully dissolve it.
- The washing powder is more prone to pollute the laundries than the detergent, therefore, please use it with proper quantity.
- Washing powder with poor quality or not used for a long period may get blocked, please clean the detergent box in time.

How to use bleach

- Fill water to the selected level, dilute the bleach in the container, and pour it slowly into the washing tub.
 - Do not use bleach for colored or figured laundries as they are prone to lose colors.
 - Do not put bleach to laundries directly.
 - Refer to the manual for the usage and quantity of the bleach.
 - Please dissolve powder bleach before use.
-
- For the quantity of the concentrated washing powder, please refer to its manual.
 - Remarks: avoid splashing of water and waste of washing powder, water level should not be too high if laundries are too small.

I Control panel instruction

- Under DELAY function, before washing, the digital timer shows preset time, unit is HOUR.
- When washing, the digital timer shows the rest time of washing, unit is MINUTES.
- When trouble encountered, the digital time shows trouble code.



- To control the washing machine is in working state or waiting state .
- After select program , processand waterlevel , press this button to start .
- Press this button to pause during working , press again will rework .
- At the beginning of start, press this button to select preset time from 2-24 hours.
- If want to cancel preset time, press POWER to make the washing machine in waiting state.

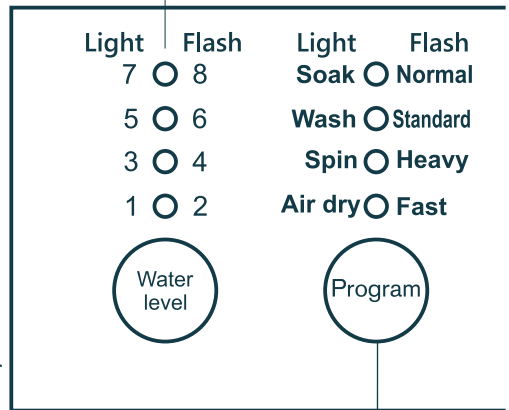
I Control panel instruction

Mode and meaning of the indicator light

 on: indicate the selected mode

 flashing: indicate the program is running

- At the beginning of start, press Water level to select water level, you can select appropriate water level. According to your laundries quantity. 1-2 is low water level, 3-5 is middle water level, 6-8 is high water level.
- When set the water level with '1,3,5 or 7', the light is always on . When set the water level with '2,4, 6 or 8', the light is on flash status.
- During wash (including rinse) , if need to add water, press Water level button to add water, un-press will stop adding. Or pause the washing machine and press Water level to select higher water level, then press Start/Pause button, The washing machine will add the water to setting level automatically and continue working. If your resetting water level is lower than present water level, the lower water Level will valid in next water inlet.
- Automatically add water : during soak, wash and rinse process, if the washing machine check the water level is lower than setting water level, The washing machine will pause and add water to setting water level automatically.



- You can select one program from 8 programs : 'Normal', 'Standard', 'Heavy', 'Fast', 'Soak', 'Wash', 'Spin', 'Airdry'.
- When set program 'soak, wash, spin or air dry', the light is always on .When set program 'normal, standard, heavy or fast', the light is on flash status.
- At the beginning of start, program settings'Normal'.

I Operation steps

1. Press power switch, put through power, the machine is in state of beginning:
- 2 . Press "program" button to select proper program.
3. Select appropriate water level according to your laundries quantity.
4. At the beginning of start, if need to select air-dry, press "Program" button to select "Air dry", When the air dry function is over, the washing machine will be in waiting state.
5. Close the top lid, press Start/Pause, the washing machine is working.
6. When the washing is finished, buzzer alarm, power supply cut off automatically.

Maintenance

Maintenance methods

After the end of the programme

- The machine stops automatically, and music buzzer will remind you to take out the laundries or start again.
- Once you have finished using the machine, you are advised to unplug it and turn off the water taps to avoid unexpected leak or fire.

External cleaning

Clean the exterior cabinet of the appliance with soft cloth. Do not use cleanser, volatile chemical materials to clean the machine, which will damage plastic parts and the surface.



Clean inlet gate

It is possible that the inlet filter net can be blocked by the dust, please clean it according to the follow steps:

1. Close the tap and turn on the power switch.
2. Start the washing machine for 5 seconds (make the water in the inlet hose flows to the tub), and cut off the power supply.
3. Pull off the inlet hose, remove and clean the inlet valve and the inlet net, and install again.



Clean the lint filter

- It is necessary to use lint filter during washing.
- After washing, please clean the lint filter in time.

Clean the lint filter according to the following steps:

1. Pull out the lint filter (see Illustration 1)
2. Open the lint filter and wash it. (see Illustration 2)
3. Close the lint filter and install it to proper position.

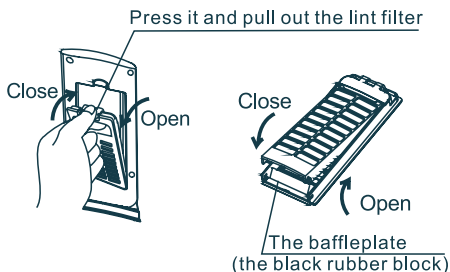


Illustration 1

Illustration 2

Maintenance

1. Once you have using the machine, you are advised to turn off the water taps.(if necessary, pull out the inlet hose)
2. Do not keep water in tub for a long time. When washing is finished , drain it right away.
3. Once you have finished using the machine, you are advised to unplug it.
4. Put the electric cable and the drain hose in order.
5. Wipe the water on the surface and in tub with soft cloth and keep the top lid opening for a while. It helps to prevent mould and stagnant smells forming inside the appliance.If the water in the inner tub has possibility to freeze,please do like below:
 1. In winter, if remaining water freeze can cause the washing machine trouble,please take off the water inlet hose and drain out the water in the hose and inner tub.
 2. If the water freeze, please don't operate the washing machine. Put 40℃ hot water in the tub, the hot water should submerge the pulsator, after a few minutes, rotate the pulsator by hand gently, then you can operate the washing machine.

I Troubleshooting

Before contacting the technicians, please make the following checks:

| Phenomena | Possible reason |
|---|--|
| Control panel has no any display | Plug is not inserted tightly No electricity in the socket Power switch is not turned on Power supply is cut off |
| Inlet hose leaks | Inlet hose connector(connecting with the tap)is not fixed tightly Inlet hose and washing machine connector is loose |
| It does not drain | Drainpipe is not put down Drainpipe is bended or get blocked |
| It does not inlet | No water supply Tap is not open Inlet hose gets blocked |
| Spin stops and begins to inlet during spin program | Laundries is too much or too little or the Machine is not place stably |
| Press the program button to select SPIN, but It does not spin | Do not close the top lid when drain is finished Open up the top lid when start drain |
| The spin is intermittent when spin starts | Balance the laundries to reach to the best spin effect |
| First time to use, some water flows from the drain hose | The remaining water when the factory make test |

I Troubleshooting

| Settlement |
|---|
| <p>Insert the plug tightly Check the socket or change to another socket Press power switch Check power supply</p> |
| <p>Install the inlet hose again Tighten the connector of the machine</p> |
| <p>Put down the drainpipe Straighten or clean the drainpipe</p> |
| <p>Restart when water supply is resumed Open the tap Clean the filter according to before “clean inlet gate”</p> |
| <p>The machine is adjusting automatically</p> |
| <p>Close the top lid Close the top lid</p> |
| <p>Normal</p> |
| <p>Normal</p> |

Notes : If there is still a fault after the above checks, please pull out the plug and contact the seller right away. It is dangerous to repair this product by yourself.

I Other functions

1. Give an alarm

| Display | Explanation | Settlement |
|---------|--|---|
| E0 | The top lid is opened when preset is started | Close the top lid and clear up the alarm |
| E1 | After draining 5 minutes, it still does not reach to water level | Open top lid, according to before troubleshooting and settlement to settle it, then close the top lid and clear up the alarm. |
| E2 | The top lid is open when spinning | Close the top lid and clear up the alarm |
| E3 | Spin does not balance | Open the top lid ,make the laundries place equally, then close it and clear up the alarm |
| E4 | After inlet 50 minutes still not reach to setting water level | Open top lid, according to before troubleshooting and settlement to settle it. Then close the tip lid and clear up the alarm |
| E5 | The top lid is opened after setting child-lock | Close the top lid and clear up the alarm |
| E6 | The water level is more than overflowing water level. | Drain the water until the water level reach the highest water level. |
| E7 | The input and output of the memory is abnormal. | Close the top lid and clear up the alarm |
| F1 | Water level sensor is wrong | Cut the power supply and call the technicians |

2. Imbalance adjustment

During spinning, if the laundries are not placed equally in the tub, it would cause violent vibration. This machine has imbalance adjustment function, and the vibration testing system will supervise the running. Once vibration is beyond certain level, the adjustment system will start automatically to adjust the imbalance.

3. Power supply is cut off automatically

- (1) If do not press START/PAUSE in 10 minutes after pressing POWER, power supply will cut off automatically.
- (2) Washing finished, power supply will cut off automatically .

4. Child lock function

When the machine running, press the buttons of "program" and "delay" at the same time 3 seconds to set child lock function, and then the LED display "CL", press the buttons of "program" and "delay" at the same time above 3 seconds again to cancel the child lock. And the machine will back to display the remain time. Once set the child lock function, all buttons are locked(including power button). If the top door is opened when the machine is running, the machine will stop to run and error alarm, the LED display "E5" and flash, if the door is closed within 5 mins after opening, the machine will stop error alarm and continue to work. If the machine door is opened more than 5 mins, and the machine will drain water until recover water level. During this time, the error alarm will sound 10 seconds every 10 mins to warn the machine have an accident, at then, close the top door is not useful

I Specifications

| | |
|----------------------------------|---|
| SKU | PCW002-159WH-USZX |
| Model | FW50-1518L |
| Rated voltage and frequency | 110-120V~ 60Hz |
| Rated capacity of wash and spin | 5.0kg (dry laundries weight) |
| Water level/water volume (about) | 1/ 20L 2/ 23L 3/ 26L 4/ 30L 5/ 33L 6/ 37L 7/ 41L 8/ 45L |
| Inlet pressure | 0.03MPa~0.85MPa |
| Rated input power | Wash: 325W spin: 260W |
| Weight | 54.01 lbs |
| Dimensions | 34.57(H) x 20.87(W) x 20.47(D) in |

Warranty and Service

We offers a limited 1-year warranty ("warranty period") on all of our products purchased new and unused from us with an original proof of purchase and where a defect has arisen, wholly or substantially, as a result of faulty manufacture, parts, or workmanship during the warranty period. The warranty does not apply where damage is caused by other factors, including without limitation:

- (a) normal wear and tear;
- (b) abuse, mishandling, accident, or failure to follow operating instructions;
- (c) exposure to liquid or infiltration of foreign particles;
- (d) servicing or modifications of the product other than by our company;

Our warranty covers all costs related to restoring the proven defective product through repair or replacement of any defective part and necessary labor so that it conforms to its original specifications. A replacement product may be provided instead of repairing a defective product. Our sole obligation under this warranty is limited to such repair or replacement. A receipt indicating the purchase date is required for any claim, so please keep all receipts in a safe place. Although greatly appreciated, the product registration is not required to activate any warranty, and product registration does not eliminate the need for the original proof of purchase. The warranty will be voided if repairs are performed by a non-authorized third party and/or if spare parts other than those provided by the Company are used. You may also arrange for service after the warranty expires, at an additional cost. These are our general terms for warranty service, but we always urge our customers to reach out to us with any issue, regardless of warranty terms. If you have an issue with our products, please contact us, and we will do our best to resolve it for you.

Call: 1-833-632-0897

Email: support@homyd.com

Working hours: Mons to Fris, 8 AM - 4 PM (PT)

