

Portable Air Conditioner Owner's Manual

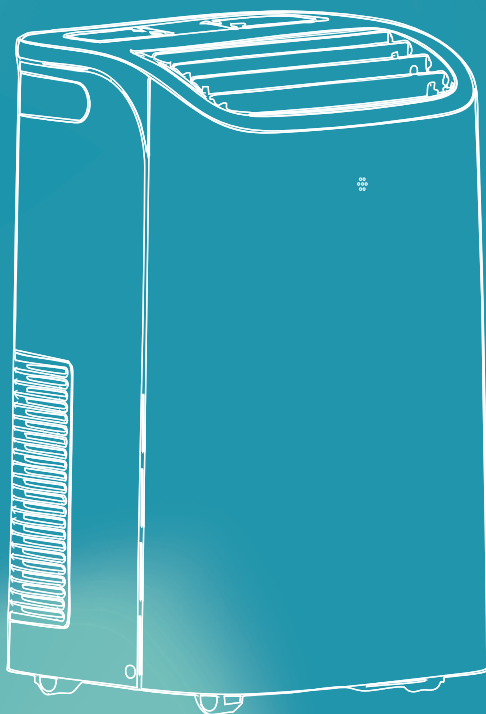

SKU: PAC004-12KWG-USZX/PAC004-14KWG-USZX
Model: YAC-08CPD/PD1|YAC-10CPD/PD1

Congratulations on purchasing your new product. To ensure proper operation, please read this instruction manual carefully before using this product. Keep this manual in a safe place for future reference.

 **Email:**
support@homyd.com
Contact Number:
1-833-986-6998

Congratulations

Dear Customer:

Welcome to our family. Thank you for purchasing one of our products.

Our goal is to provide you with superior service. If there is anything missing from or wrong with your order, or if you have any questions about using our Air Conditioner, PLEASE contact us.

Email: support@homyd.com

Contact Number: 1-833-986-6998 (Mons to Fris,8 AM-4 PM(PT))

Our team is available 24/7 to address your questions, comments, and concerns. Your satisfaction is our ultimate goal. We want to make everything right so you'll share your positive experience with other shoppers on Amazon.

If you experience any problems, please send an email to support@homyd.com. Contact Number: 1-833-986-6998 (Mons to Fris,8 AM-4 PM(PT)).

CONTENTS

IMPORTANT SAFEGUARDS 02-06

GENERAL INSTRUCTIONS 06-14

DESCRIPTION AND ACCESSORIES 15

INSTALLATION INSTRUCTIONS 16-18
DESCRIPTION OF THE DISPLAY

SCREEN AND CONTROL PANEL 19-28

TIPS FOR CORRECT USE 28-32

TROUBLESHOOTING 32-33

IMPORTANT SAFEGUARDS

- This appliance is for household use only.
 - Disconnect the appliance from its power source during service and when replacing parts and cleaning.
 - Please note: Check the nameplate for the type of refrigerant gas used in your appliance.
 - Specific information regarding appliances with refrigerant gas.
- It is recommended that the cooling circuit of the machine not be pierced. At the end of its useful life, deliver the appliance to a special waste collection center for disposal.
GWP(Global Warming Potential): R410A: 2088, R134a: 1430, R290: 3, R32: 675.

- This hermetically sealed system contains fluorinated greenhouse gases.
- ENVIRONMENTAL INFORMATION: This unit contains fluoridated greenhouse gases covered by the Kyoto Protocol.
- Do not use this unit for functions other than those described in this instruction manual.
- Make sure the plug is plugged firmly and completely into the outlet. If not, it can result in the risk of electric shock or fire.
- Do not plug other appliances into the same outlet. It can result in the risk of electric shock.
- Do not disassemble or modify the appliance or the power cord. It can result in the risk of electric shock or fire. All other services should be referred to a qualified technician.
- Do not place the power cord or appliance near a heater, radiator, or other heat source. It can result in the risk of electric shock or fire.
- This unit is equipped with a cord with an earthed wire connected to an earthed pin or grounding tab. The plug must be plugged into a properly installed and earthed socket. Under no circumstances should you cut or remove the earthed pin or grounding tab from this plug.
- The unit should be used or stored so that it is protected from moisture, e.g., condensation, splashed water, etc. Unplug the unit immediately if this occurs.
- Always transport your appliance in a vertical position and place it on a stable, level surface during use. If the unit is transported lying on its side, it should be stood up and left unplugged for 6 hours.
- Always use the switch on the control panel or remote controller to turn the unit off. Do not start or stop the operation by plugging in or unplugging the power cord. It can result in the risk of electric shock.
- Do not use hazardous chemicals to clean or come into contact with the unit. Use only a soft cloth to clean the appliance to prevent damage to the surface finish. Do not use wax, thinner, or a strong detergent. Do not use the unit in the presence of inflammable substances or vapor, such as alcohol, insecticides, gasoline, etc.
- If the appliance makes unusual sounds or emits smoke or an unusual odor, unplug it immediately.
- Do not clean the unit with water. Water can enter the unit and damage the insulation, creating a shock hazard. If water enters the unit, unplug it immediately and contact Customer Service.
- Utilize two or more people to lift and install the unit.

- Always grasp the plug when plugging in or unplugging the appliance. Never unplug by pulling on the cord. It can result in the risk of electrical shock and damage.
- Install the appliance on a sturdy, level floor that supports up to 110lbs(50kg). Installation on a weak or unlevel floor can result in the risk of property damage and personal injury.
- Details of type and rating of fuses: T, 250V AC, 3.15A.

WARNING

This appliance is not intended for use by persons (including children) with reduced physical, sensory, or mental capabilities or lack of experience and knowledge unless they have been given supervision or instruction concerning the use of the appliance by a person responsible for their safety.

Children should be supervised to ensure that they do not play with the appliance.

If the SUPPLY CORD is damaged, it must be replaced by the manufacturer, its service agent, or similarly qualified persons in order to avoid a hazard.

The appliance shall be installed in accordance with national wiring regulations.

Do not use alternate methods to accelerate the defrosting process or to clean other than those recommended by the manufacturer.

The appliance shall be stored in a room without continuously operating ignition sources (for example, open flames, an operating gas appliance, or an operating electric heater.)

Do not pierce or burn.

Be aware that refrigerants may not contain an odor.

WARNING

The handling, installation, storage, servicing, and disposal must comply with the provisions of gas-related national laws and regulations and national wiring regulations.

It is necessary to clear away the refrigerant in the system when maintaining or scrapping an appliance.

Ventilated area (open doors and windows)

Ensure the working area is open or well-ventilated before turning on the system or performing hot work. Ventilation should be maintained during operation. Ventilation quickly displaces safely diluted leaked refrigerant into the atmosphere.

Flammable refrigerant R32/R290 is used within the appliance. Please follow the instructions carefully to handle, install, clean, and service the appliance to avoid damage or hazards. Do not dispose of this appliance in regular trash. Contact a qualified agency for proper disposal.

Servicing shall be performed only as recommended by the manufacturer.



Information for qualification of workers

All operators or refrigeration system maintenance personnel shall have a valid certificate issued by an industry-recognized evaluation body to certify that they are qualified for the safe disposal of refrigerant agents as recognized by the industry;

- Maintain and repair the equipment only in accordance with the method recommended by the equipment manufacturer. If other professionals are required to assist in the maintenance and repair of equipment, do so under the supervision of personnel qualified to use combustible refrigerants.

HH.1 General

Information on procedures: When installing or servicing an appliance with FLAMMABLE REFRIGERANTS, additional information on refrigerating appliance installation, repair, maintenance, and decommission procedures is required.

The training of these procedures is carried out by national training organizations or manufacturers that are accredited to teach the relevant national competency standards that may be set in legislation.

The achieved competence should be documented by a certificate.

HH.2 Information and training

HH.2.1 The training should include the substance of the following:

HH.2.2 Information about the explosion potential of FLAMMABLE REFRIGERANTS to show that flammables may be dangerous when handled without care.

HH.2.3 Information about POTENTIAL IGNITION SOURCES, especially those that are not obvious, such as lighters, light switches, vacuum cleaners, and electric heaters.

HH.2.4 Information about the different safety concepts:

Unventilated – The appliance's safety does not depend on housing ventilation. Switching off the appliance or opening the housing does not significantly affect safety. Nevertheless, it is possible that leaking refrigerant may accumulate inside the enclosure, and flammable gas will be released when the enclosure is opened.

Ventilated enclosure – The appliance's safety depends on housing ventilation. Switching off the appliance or opening of the enclosure significantly affects the safety. Care should be taken to ensure sufficient ventilation beforehand.

Ventilated room – The appliance's safety depends on the room's ventilation. Switching off the appliance or opening the housing does not significantly affect safety. The ventilation of the room shall not be switched off during repair procedures.

HH.2.5 Information about refrigerant detectors:

- Principle of function, including influences on the operation.
- Procedures, such as how to safely repair, check, or replace a refrigerant detector or parts of it.
- Procedures, such as how to disable a refrigerant detector in case of repair work on the refrigerant-carrying parts.

HH.2.6 Information about the concept of sealed components and sealed enclosures according to IEC 60079-15:2010.

a) Commissioning

-
- Ensure that the floor area is sufficient for the REFRIGERANT CHARGE or that the ventilation duct is assembled correctly.
 - Connect the pipes and perform a leak test before charging with refrigerant.
 - Check safety equipment before putting into service.

b) Maintenance

- Portable equipment shall be repaired outside or in a workshop specially equipped for servicing units with FLAMMABLE REFRIGERANTS.
- Ensure sufficient ventilation at the repair place.
- Be aware that equipment malfunction may be caused by refrigerant loss, and a refrigerant leak is possible.
- Discharge capacitors in a way that won't cause any spark. The standard procedure to short-circuit the capacitor terminals usually creates sparks.
- Reassemble sealed enclosures accurately. If seals are worn, replace them.
- Check safety equipment before putting into service.

c) Repair

- Portable equipment shall be repaired outside or in a workshop specially equipped for servicing units with FLAMMABLE REFRIGERANTS.
- Ensure sufficient ventilation at the repair place.
- Be aware that equipment malfunction may be caused by refrigerant loss, and a refrigerant leak is possible.
- Discharge capacitors in a way that won't cause any spark.
- When brazing is required, the following procedures shall be carried out in the following order:
 - Safely remove the refrigerant following local and national regulations. If the recovery is not required by national regulations, drain the refrigerant to the outside. Take care that the drained refrigerant will not cause any danger. In doubt, one person should guard the outlet. Take special care that drained refrigerant will not flow back into the building;
 - Purge the refrigerant circuit with oxygen-free nitrogen;
 - Evacuate the refrigerant circuit;
 - Purge the refrigerant circuit with nitrogen for 5 minutes (not required for A2L refrigerants).
 - Evacuate again (not required for A2L refrigerants).
 - Remove parts to be replaced by cutting or brazing.
 - Purge the braze point with nitrogen during the brazing procedure required for repair.
 - Carry out a leak test before charging with refrigerant.
- Reassemble sealed enclosures accurately. If seals are worn, replace them.
- Check safety equipment before putting into service.

d) Decommissioning

- If safety is affected while the equipment is being put out of service, the REFRIGERANT CHARGE shall be removed before decommissioning.
- Ensure sufficient ventilation at the equipment location.
- Be aware that equipment malfunction may be caused by refrigerant loss, and a refrigerant leak is possible.
- Discharge capacitors in a way that won't cause any spark.
- Remove the refrigerant. If the recovery is not required by national regulations, drain the refrigerant to the outside. Take care that the drained refrigerant will not cause any danger. In doubt, one person should guard the outlet. Take special care that drained refrigerant will not flow back into the building.
- When FLAMMABLE REFRIGERANTS except A2L REFRIGERANTS are used,

-
- Evacuate the refrigerant circuit.
 - Purge the refrigerant circuit with nitrogen for 5 min.
 - Evacuate again.
 - Fill with nitrogen up to atmospheric pressure.
 - Put a label on the equipment that the refrigerant has been removed.

e) Disposal

- Ensure sufficient ventilation at the workplace.
- Remove the refrigerant. If the recovery is not required by national regulations, drain the refrigerant to the outside. Take care that the drained refrigerant will not cause any danger. In doubt, one person should guard the outlet. Take special care that drained refrigerant will not flow back into the building.
- When flammable refrigerants are used,
 - a) Evacuate the refrigerant circuit.
 - b) Purge the refrigerant circuit with oxygen-free nitrogen.
 - c) Evacuate again. (not required for A2L refrigerants).
 - d) Disconnect and remove the compressor. Drain the oil.

GENERAL INSTRUCTIONS

1.1 Checks to the area

Before beginning work on systems containing flammable refrigerants, safety checks are necessary to ensure that the risk of ignition is minimized. For repair to the refrigerating system, the following precautions shall be taken prior to conducting work on the system.

1.2 Work procedure

Work shall be undertaken under a controlled procedure so as to minimize the risk of flammable gas or vapor being present while the work is being performed.

1.3 General work area

All maintenance staff and others working in the local area shall be instructed on the nature of the work being carried out. Work in confined spaces shall be avoided. The area around the workspace shall be sectioned off. Ensure that the conditions within the area have been made safe by controlling the use of flammable material.

1.4 Checking for the presence of refrigerant

The area shall be checked with an appropriate refrigerant detector prior to and during work to ensure the technician is aware of potentially flammable atmospheres. Ensure that the leak detection equipment being used is suitable for use with flammable refrigerants, i.e., nonsparking, adequately sealed, or intrinsically safe.

1.5 Presence of fire extinguisher

If any hot work is to be conducted on the refrigeration equipment or any associated parts, the appropriate fire extinguishing equipment shall be available on hand. Have a dry powder or CO 2 fire extinguisher adjacent to the charging area.

1.6 No ignition sources

No person carrying out work in relation to a refrigeration system that involves exposing any pipe work that contains or has contained flammable refrigerant shall use any ignition sources in such a manner that it may lead to the risk of fire or explosion. All possible ignition sources, including cigarette smoking, should be kept sufficiently far away from the installation site, repairing, removing, and disposal, during which flammable refrigerant can possibly be released into the surrounding space. Before work occurs, the area around the equipment is to be surveyed to ensure there are no flammable hazards or ignition risks. "No Smoking" signs shall be displayed.

1.7 Ventilated area

Ensure that the area is open or adequately ventilated before breaking into the system or conducting any hot work. A degree of ventilation shall continue during the period that the work is carried out. The ventilation should safely disperse any released refrigerant and preferably expel it externally into the atmosphere.

1.8 Checks of the refrigeration equipment

Where electrical components are being changed, they shall be fit for the purpose and to the correct specification. At all times, the manufacturer's maintenance and service guidelines will be followed. If in doubt, consult the manufacturer's technical department for assistance. The following checks shall be applied to installations using flammable refrigerants: the charge size is in accordance with the room size within which the refrigerant-containing parts are installed; the ventilation machinery and outlets are operating adequately and are not obstructed; if an indirect refrigerating circuit is being used, the secondary circuit shall be checked for the presence of refrigerant; marking to the equipment continues to be visible and legible; markings and signs that are illegible shall be corrected; refrigeration pipe or components are installed in a position where they are unlikely to be exposed to any substance which may corrode refrigerant containing components unless the components are constructed of materials which are inherently resistant to being corroded or are suitably protected against being corroded.

1.9 Checks of electrical devices

Repair and maintenance of electrical components shall include initial safety checks and component inspection procedures. If a fault exists that could compromise safety, then no electrical supply shall be connected to the circuit until it is satisfactorily dealt with. If the fault cannot be corrected immediately but it is necessary to continue operation, an adequate temporary solution shall be used. This shall be reported to the equipment owner so all parties are advised.

Initial safety checks shall include that capacitors are discharged; this shall be done safely to avoid the possibility of sparking; that no live electrical components and wiring are exposed

while charging, recovering, or purging the system; and that there is continuity of earth bonding.

REPAIRS TO SEALED COMPONENTS

2.1 During repairs to sealed components, all electrical supplies shall be disconnected from the equipment being worked upon prior to removing sealed covers, etc. If it is absolutely necessary to have an electrical supply to equipment during servicing, then a permanently operating form of leak detection shall be located at the most critical point to warn of a potentially hazardous situation.

2.2 Particular attention shall be paid to the following to ensure that by working on electrical components, the casing is not altered in such a way that the level of protection is affected. This shall include damage to cables, excessive number of connections, terminals not made to original specification, damage to seals, incorrect fitting of glands, etc. Ensure that the apparatus is mounted securely. Ensure that seals or sealing materials have not degraded such that they no longer prevent the ingress of flammable atmospheres. Replacement parts shall be in accordance with the manufacturer's specifications.

NOTE: The use of silicon sealant may inhibit the effectiveness of some types of leak detection equipment. Intrinsically safe components do not have to be isolated prior to working on them.

REPAIR TO INTRINSICALLY SAFE COMPONENTS

Do not apply any permanent inductive or capacitance loads to the circuit without ensuring that this will not exceed the permissible voltage and current permitted for the equipment. Intrinsically safe components are the only types that can be worked on while in the presence of a flammable atmosphere. The test apparatus shall be at the correct rating. Replace components only with parts specified by the manufacturer. Other parts may result in the ignition of refrigerant in the atmosphere from a leak.

CABLING

Check that cabling is not subject to wear, corrosion, excessive pressure, vibration, sharp edges, or any other adverse environmental effects. The check shall also take into account the effects of aging or continual vibration from sources such as compressors or fans.

DETECTION OF FLAMMABLE REFRIGERANTS

Under no circumstances shall potential ignition sources be used to search for or detect refrigerant leaks. A halide torch (or any other detector using a naked flame) shall not be used.

The following leak detection methods are deemed acceptable for all refrigerant systems. Electronic leak detectors may be used to detect refrigerant leaks. However, in the case of FLAMMABLE REFRIGERANTS, the sensitivity may not be adequate or need re-calibration. (Detection equipment shall be calibrated in a refrigerant-free area.) Ensure that the detector is not a potential ignition source and is suitable for the refrigerant used. Leak detection

equipment shall be set at a percentage of the LFL of the refrigerant. It shall be calibrated to the refrigerant employed, and the appropriate percentage of gas (25% maximum) is confirmed.

Leak detection fluids are also suitable for use with most refrigerants, but detergents containing chlorine should be avoided as the chlorine may react with the refrigerant and corrode the copper pipework.

NOTE: Examples of leak detection fluids are

- bubble method,
- fluorescent method agents.

If a leak is suspected, all naked flames shall be removed/extinguished.

If refrigerant leakage is found, which requires brazing, all of the refrigerant shall be recovered from the system or isolated (utilizing shut-off valves) in a part of the system remote from the leak. Removal of refrigerant shall be done according to REMOVAL AND EVACUATION, as shown below.

REMOVAL AND EVACUATION

Conventional procedures shall be used when breaking into the refrigerant circuit to make repairs – or for any other purpose. However, for flammable refrigerants, it is crucial that best practices be followed since flammability is a consideration. The following procedure shall be adhered to:

- a) safely remove refrigerant following local and national regulations;
- b) purge the circuit with inert gas;
- c) evacuate (optional for A2L);
- d) purge with inert gas (optional for A2L);
- e) open the circuit by cutting or brazing.

If local and national codes do not allow venting, the refrigerant charge shall be recovered into the correct recovery cylinders. For appliances containing flammable refrigerants, the system shall be purged with oxygen-free nitrogen to render the appliance safe for flammable refrigerants. This process might need to be repeated several times. Compressed air or oxygen shall not be used to purge refrigerant systems.

For appliances containing flammable refrigerants, refrigerant purging shall be achieved by breaking the vacuum in the system with oxygen-free nitrogen and continuing to fill until the working pressure is achieved, then venting to the atmosphere, and finally pulling down to a vacuum (optional for A2L). This process shall be repeated until no refrigerant is within the system (optional for A2L). When the final oxygen-free nitrogen charge is used, the system shall be vented to atmospheric pressure to enable work to occur.

Ensure that the outlet for the vacuum pump is not close to any potential ignition sources and that ventilation is available.

CHARGING PROCEDURES

In addition to conventional charging procedures, the following requirements shall be followed.

- Ensure that contamination of different refrigerants does not occur when charging equipment is used. Hoses or lines shall be as short as possible to minimize the amount of refrigerant contained in them.

-
- Cylinders shall be kept upright.
 - Ensure the refrigeration system is earthed before charging the system with refrigerant.
 - Label the system when charging is complete (if not already).
 - Extreme care shall be taken not to overfill the refrigeration system.

Prior to recharging the system, it shall be pressure tested by OFN. The system shall be leak tested on completion of charging but before commissioning. A follow-up leak test shall be carried out prior to leaving the site.

DECOMMISSIONING

Before carrying out this procedure, it is essential that the technician is entirely familiar with the equipment and all its details. It is recommended good practice that all refrigerants are recovered safely. Before the task is carried out, an oil and refrigerant sample shall be taken in case analysis is required before reclaimed refrigerant re-use. Electrical power must be available before the task is commenced.

- a) Become familiar with the equipment and its operation.
- b) Isolate system electrically.
- c) Before attempting the procedure, ensure that: mechanical handling equipment is available, if required, for handling refrigerant cylinders; all personal protective equipment is available and being used correctly; the recovery process is supervised at all times by a competent person; recovery equipment and cylinders conform to the appropriate standards.
- d) Pump down the refrigerant system, if possible.
- e) If a vacuum is not possible, make a manifold so that refrigerant can be removed from various parts of the system.
- f) Make sure that the cylinder is situated on the scales before recovery occurs.
- g) Start the recovery machine and operate it in accordance with the manufacturer's instructions.
- h) Do not overfill cylinders. (No more than 80% volume liquid charge).
- i) Do not exceed the maximum working pressure of the cylinder, even temporarily.
- j) When the cylinders have been filled correctly and the process completed, make sure that the cylinders and the equipment are removed from the site promptly and all isolation valves on the equipment are closed off.
- k) The recovered refrigerant shall not be charged to another refrigeration system unless it has been cleaned and checked.

LABELING

Equipment shall be labeled stating that it has been decommissioned and emptied of refrigerant. The label shall be dated and signed.

Ensure there are labels on the equipment stating the equipment contains flammable refrigerant.

RECOVERY

When removing refrigerant from a system, either for servicing or decommissioning, it is recommended good practice that all refrigerants are removed safely. When transferring refrigerant into cylinders, ensure that only appropriate refrigerant recovery cylinders are

employed. Ensure the correct number of cylinders for holding the total system charge is available. All cylinders to be used are designated for the recovered refrigerant and labeled for that refrigerant (i.e., special cylinders for the recovery of refrigerant). Cylinders shall be complete with pressure relief valves and associated shut-off valves and be in good working order. Empty recovery cylinders are evacuated and, if possible, cooled before recovery occurs.

The recovery equipment shall be in good working order, with a set of instructions concerning the equipment at hand. It shall be suitable for the recovery of flammable refrigerants. In addition, a set of calibrated weighing scales shall be available and in good working order. Hoses shall be complete with leak-free disconnect couplings and in good condition. Before using the recovery machine, check that it is in satisfactory working order, has been properly maintained, and that any associated electrical components are sealed to prevent ignition in the event of a refrigerant release. Consult the manufacturer if in doubt.

The recovered refrigerant shall be returned to the refrigerant supplier in the correct recovery cylinder, and the relevant Waste Transfer Note is attached. Do not mix refrigerants in recovery units, especially not in cylinders.

If compressors or compressor oils are to be removed, confirm they have been evacuated to an acceptable level to ensure that flammable refrigerant does not remain within the lubricant. The evacuation process shall be carried out prior to returning the compressor to the suppliers. Only electric heating to the compressor body shall be employed to accelerate this process. When oil is drained from a system, it shall be carried out safely.

According to the US and CANADA rules:



CAN ICES-003 (B)/NMB-003(B)

FCC Caution

This device complies with part 15 of the FCC Rules. Operation is subject to the following two conditions:

(1) This device may not cause harmful interference, and (2) this device must accept any interference received, including interference that may cause undesired operation.

Any changes or modifications not expressly approved by the party responsible for compliance could void the user's authority to operate the equipment.

Note: This equipment has been tested and found to comply with the limits for a Class B digital device, pursuant to part 15 of the FCC Rules. These limits are designed to provide reasonable protection against harmful interference in a residential installation. This equipment generates uses and can radiate radio frequency energy. If not installed and used in accordance with the instructions, it may cause harmful interference to radio communications. However, there is no guarantee that interference will not occur in a particular installation. If this equipment does cause harmful interference to radio or television reception, which can be determined by turning the equipment off and on, the user is encouraged to try to correct the interference by one or more of the following measures:

-
- Reorient or relocate the receiving antenna.
 - Increase the separation between the equipment and receiver.
 - Connect the equipment to an outlet on a circuit different from that to which the receiver is connected.
 - Consult the dealer or an experienced radio/TV technician for help.

IC Warning

This device complies with Industry Canada's license-exempt RSSs. Operation is subject to the following two conditions:

- (1) This device may not cause interference; and
- (2) This device must accept any interference, including interference that may cause undesired operation of the device.

Cet appareil est conforme aux CNR exemptes de licence d'Industrie Canada . Son fonctionnement est soumis aux deux conditions suivantes :

- (1) Ce dispositif ne peut causer d'interférences ; et
- (2) Ce dispositif doit accepter toute interférence , y compris les interférences qui peuvent causer un mauvais fonctionnement de l'appareil.

IMPORTANT SAFEGUARDS

- This appliance is for household use only.
- Disconnect the appliance from its power source during service and when replacing parts and cleaning.
- Please note: Check the nameplate for the type of refrigerant gas used in your appliance.
- Specific information regarding appliances with refrigerant gas.

It is recommended that the cooling circuit of the machine not be pierced. At the end of its useful life, deliver the appliance to a special waste collection center for disposal.

GWP(Global Warming Potential): R410A: 2088, R134a: 1430, R290: 3, R32: 675.

- This hermetically sealed system contains fluoridated greenhouse gases.
- ENVIRONMENTAL INFORMATION: This unit contains fluoridated greenhouse gases covered by the Kyoto Protocol.
- Do not use this unit for functions other than those described in this instruction manual.
- Make sure the plug is plugged firmly and completely into the outlet. It can result in the risk of electric shock or fire.
- Do not plug other appliances into the same outlet; it can result in the risk of electric shock.
- Do not disassemble or modify the appliance or the power cord; it can result in the risk of electric shock or fire. All other services should be referred to a qualified technician.
- Do not place the power cord or appliance near a heater, radiator, or other heat source. It can result in the risk of electric shock or fire.
- This unit is equipped with a cord with an earthed wire connected to an earthed pin or grounding tab. The plug must be plugged into a properly installed and earthed socket. Under no circumstances should you cut or remove the earthed pin or grounding tab from this plug.
- The unit should be used or stored to protect it from moisture, e.g., condensation, splashed water, etc. Unplug the unit immediately if this occurs.
- Always transport your appliance in a vertical position and place it on a stable, level surface during use. If the unit is transported lying on its side, it should be stood up and left unplugged for 6 hours.
- Always use the switch on the control panel or remote controller to turn the unit off. Do not start or stop the operation by plugging in or unplugging the power cord. It can result in the risk of electric shock.
- Do not touch the buttons on the control panel with your wet and damp fingers.
- Do not use hazardous chemicals to clean or come into contact with the unit. Use only a soft cloth to clean the appliance to prevent damage to the surface finish. Do not use wax, thinner, or a strong detergent. Do not use the unit in the presence of inflammable substances or vapor, such as alcohol, insecticides, gasoline, etc.
- If the appliance makes unusual sounds or emits smoke or an unusual odor, unplug it immediately.
- Do not clean the unit with water. Water can enter the unit and damage the insulation, creating a shock hazard. If water enters the unit, unplug it immediately and contact Customer Service.
- Utilize two or more people to lift and install the unit.
- Always grasp the plug when plugging in or unplugging the appliance. Never unplug by pulling on the cord. It can result in the risk of electrical shock and damage.

-
- Install the appliance on a sturdy, level floor that supports up to 110lbs(50kg). Installation on a weak or unlevel floor can result in the risk of property damage and personal injury.
 - If the appliance has the Wi-Fi function, the transmission power is less than 20dBm, and the radio frequency range is 2412MHz-2472MHz.
 - This appliance is not intended for use by persons (including children)with reduced physical, sensory, or mental capabilities or lack of experience and knowledge unless they have been given supervision or instruction concerning the use of the appliance by a person responsible for their safety.
 - Children should be supervised to ensure that they do not play with the appliance.
 - If the SUPPLY CORD is damaged, it must be replaced by the manufacturer, service agent, or similarly qualified persons to avoid a hazard.
 - The appliance shall be installed in accordance with national wiring regulations.

According to the IEC standard:

- This appliance is not intended for use by persons (including children) with reduced physical, sensory, or mental capabilities or lack of experience and knowledge unless they have been given supervision or instruction concerning the use of the appliance by a person responsible for their safety.
- Children should be supervised to ensure that they do not play with the appliance.
- If the supply cord is damaged, it must be replaced by the manufacturer, service agent, or similarly qualified persons to avoid a hazard.
- The appliance shall be installed in accordance with national wiring regulations.

IMPORTANT - GROUNDING METHOD

This product is factory-equipped with a power supply cord that has a three-pronged grounded plug. It must be plugged into a mating grounding-type receptacle in accordance with the National Electrical Code and applicable local codes and ordinances. If the circuit does not have a grounding-type receptacle, it is the responsibility and obligation of the customer to exchange the existing receptacle in accordance with the National Electrical Code and applicable local codes and ordinances. The third ground prong should not, under any circumstances, be cut or removed. Never use the cord, the plug, or the appliance when they show any sign of damage. Do not use your appliance with an extension cord unless it has been checked and tested by a qualified electrical supplier. Improper connection of the grounding plug can result in the risk of fire, electric shock, and/or injury to persons associated with the appliance. If in doubt that the appliance is grounded correctly, check with a qualified service representative.

ELECTRICAL CONNECTIONS

Before plugging the appliance into the main socket, check that:



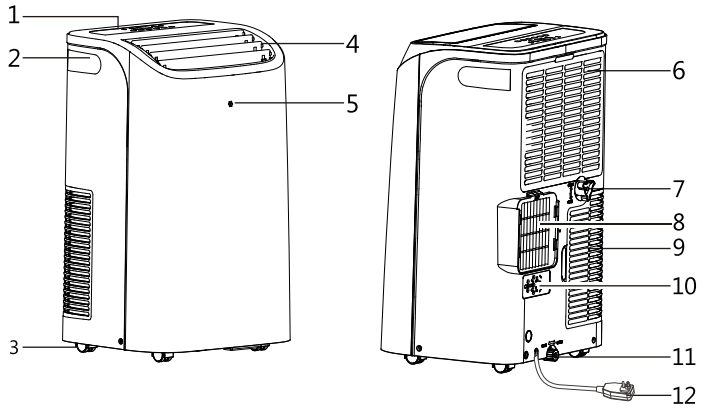

- The main power supply corresponds to the value indicated on the rating plate on the back of the appliance.
- The power socket and electrical circuit are adequate for the appliance.
- The main socket matches the plug. If this is not the case, have the plug replaced.
- The main socket is adequately earthed. Failure to follow these important safety instructions absolves the manufacturer of all liability.

DESCRIPTION

1. Control panel
2. Handle (both sides)
3. Castors
4. Deflector
5. Remote control receiver
6. Intake grille
7. Middle drainage
8. Air outlet grille
9. Intake grille
10. Plug fixer
11. Condenser drain
12. Power cable

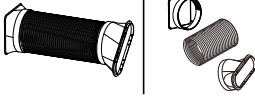

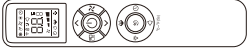
ACCESSORIES

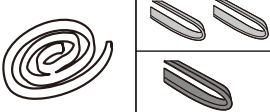
PARTS	NAME	QUANTITY	
	Hose inlet Exhaust hose Hose outlet	1 set	x1 x1 x1
	Window slider without hole (A) Window slider with hole (B)	1 set	x1 x1
	Bolts: Metal locking screw		x2
	Remote Control		x1
	Drainage hose		x1
	Foam seal A (adhesive type) size:1000x40x4mm	x1	x2
	Foam seal B (no adhesive type) size:1000x40x20mm		x1

NOTE:

All the illustrations in this manual are for explanatory purposes only. Your appliance may be slightly different. Be sure all accessories are removed from the packing before use.

INSTALLATION INSTRUCTIONS

EXHAUSTING HOT AIR

When using the appliance in Cool mode, the hot air exchange of the condenser must be exhausted completely out of the room.

- The exhaust duct assembly has been assembled and does not need to be connected again. Please check (fig.1)

If you find that the connector is loose or dropped, it can be fixed and connected according to (fig. 2) and (fig. 3).

1 Extend either side of the hose (Fig.1), and screw the hose inlet (Fig.3).

2 Extend the other side of the hose and screw it to the hose outlet (Fig.3).

- Install the hose inlet into the unit (Fig.4).
- Affix the hose outlet into the window slider kit and seal. (Fig.5 &6).

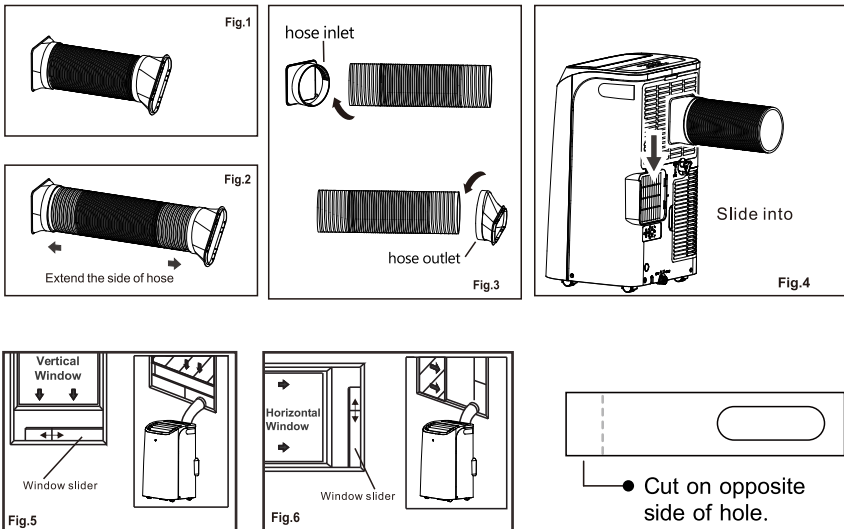

The window slider kit has been designed to fit most standard vertical and horizontal window applications; however, you may need to modify some aspects of the installation procedures for certain types of windows. The window slider kit can be fastened with screws.

NOTE: If the window opening is less than the minimum length of the window slider kit, cut the end without the hold in it short enough to fit in the window opening. Never cut out the hole in the window slider kit.

WINDOW SLIDER KIT INSTALLATION

1:Parts:

- A) Window slider without hole
- B) Window slider with one hole
- C) Screw/Pin

2: Assembly:

Slide Panel B into Panel A and size to window width.

Windows sizes vary. When taking measurements, be sure that the window kit assembly is free from gaps and/or air pockets when sizing the window width.

3: Lock the screw/pin

Lock the screw/pin into the holes that correspond with the width that your window requires to ensure that there are no gaps or air pockets in the window kit assembly after installation.

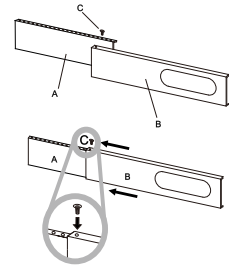

LOCATION

- The unit should be placed on a firm foundation to minimize noise and vibration. For safe and secure positioning, place the unit on a smooth, level floor strong enough to support it.
- The unit has casters to aid placement but should only be rolled on smooth, flat surfaces. Use caution when rolling on carpeted surfaces. Use caution and protect floors when rolling over wood floors. Do not attempt to roll the unit over objects.
- The unit must be placed within reach of a properly rated grounded socket.
- Never place any obstacles around the air inlet or outlet of the unit.
- Allow at least 18"(45cm) of space around and above; space away from the wall for efficient working. (Fig.7)
- The hose can be extended, but it is best to keep the length to the minimum required. Also, ensure that the hose has no sharp bends or sags. (Fig.8)

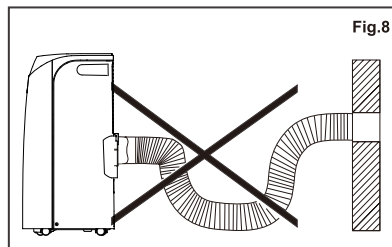
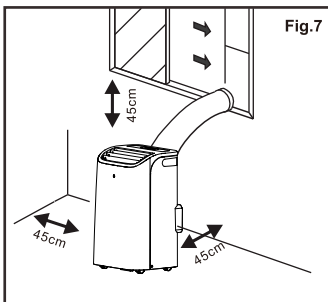

INSTALLATION INSTRUCTIONS

DOUBLE-HUNG SASH/SLIDING SASH WINDOW INSTALLATION

1. Open the window. Cut the foam seal (adhesive type) to the proper length and attach it to the window inside. (Fig.9)
2. Attach the window slider kit to the window sash. Adjust the length of the window slider kit according to the width of the window. (Fig.10)
3. Close the window securely against the window slider kit. (Fig.11)
4. Cut the foam seal (no adhesive type) to an appropriate length and seal the open gap between the top and outer window frames. (Fig.12)

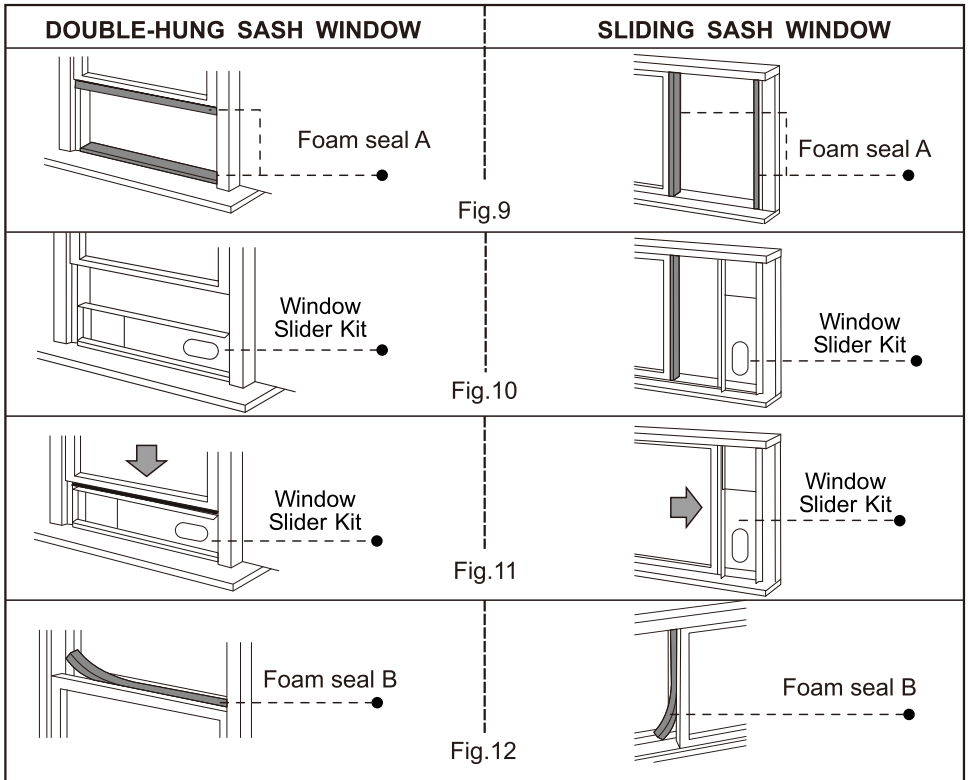

DESCRIPTION OF THE DISPLAY SCREEN AND CONTROL PANEL

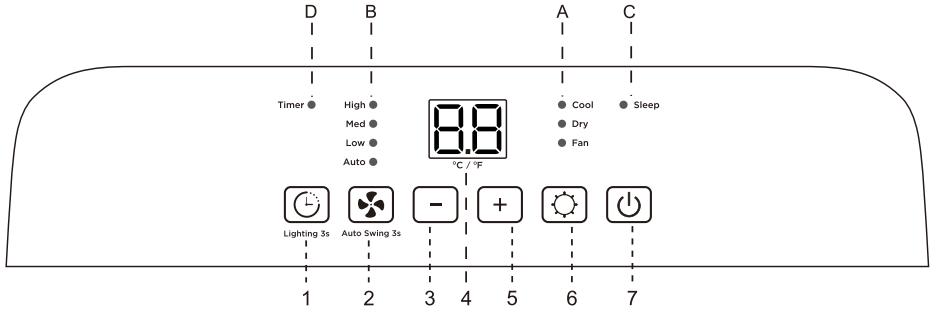

1. Timer button
 2. Fan speed button
 3. Decrease button
 4. Display screen
 5. Increase button
 6. MODE button
 7. ON/OFF button
- A. Mode symbol
B. Fan speed symbol
C. Sleep symbol
D. Timer symbol

TURNING THE APPLIANCE ON

Plug into the main socket, and then the appliance is on standby.



Press the  button to turn the appliance on.

The last function active (last used setting) when it was turned off will appear.

COOL mode

Ideal for hot, muggy weather when you need to cool and dehumidify the room.

To set this mode correctly:

- Press the  button several times until the "Cool" symbol appears.
- Select the target temperature 16°C-31°C (61°F -88°F) by pressing the - or + button until the corresponding value is displayed.
- Select the required fan speed by pressing the  button.

Four speeds are available: High / Med / Low / Auto.



The most suitable temperature for the room during the summer varies from 24°C to 27°C (75°F to 81°F). You are recommended, however, not to set a temperature much below the outdoor temperature. The fan speed difference is more noticeable when the appliance is under Fan mode but may not be noticeable under Cool mode.

FAN mode

When using the appliance in this mode, the air hose does not



need to be attached.

- Press the  button several times until the “Fan” symbol appears.
- Select the required fan speed by pressing the  button.

Three speeds are available: High / Med / Low.

DRY mode

Ideal to reduce room humidity (Spring and Autumn, damp rooms, rainy periods, etc). In Dry mode, the appliance should be prepared the same as in Cool mode, with the air exhaust hose attached to enable the moisture to be discharged outside.

To set this mode correctly:



- Press the  button several times until the Dry symbol appears.
- Select the target temperature 16°C-31°C(61°F-88°F) by pressing the - or + button until the corresponding value is displayed.
- In this mode, the appliance selects fan speed automatically and cannot be set manually.

Auto mode

The appliance chooses automatically whether to operate in Cool or Fan mode.

To set this mode correctly:

- Press the  button a number of times until the screen shows the following:



- Select the required fan speed by pressing the  button.

Four speeds are available: High / Med / Low / Auto.

If the appliance is a cooling-only model, the unit operates in Fan mode when the room temperature is below 23°C (73°F) and Cool mode when the room temperature is above 25°C(77°F).

SETTING THE TIMER

-The Timer can be used to delay the appliance start-up or shutdown; this avoids wasting electricity by optimizing operating periods.

* Programming start-up

- Turn on the appliance and choose the mode you want, for example, Dehumidify mode, high fan speed. Turn off the appliance.

- Press the "  " button, and the screen starts to flash. Press the " - " / " + " to adjust the set time from 0.5-24 hours.

- In 5 seconds without the operation, the timer starts the function, then the "Timer" symbol lights.

- Press the "  " button again to cancel the Timer, and the "Timer" symbol disappears.

* Programming shut down

- When the appliance is running, press the "  " button, and the screen starts to flash.

- Press the " - " / " + " to adjust the set time from 0.5-24 hours.

- In 5 seconds without the operation, the timer start the function, then the " Timer" symbol lights.

- Press the "  " button again to cancel the Timer, and the " Timer " symbol disappears.



LIGHT function

This function is applicable to sleep at night. When the machine is running, you can press and hold the "TIMER" button for 3 seconds, and the display screen will be turned off. When pressed and held again, all display lights will resume.

SWING function

This function moves the deflectors to adjust the direction of the airflow.

To set this function correctly:

- Select the operating mode (Cool, Dry, Fan) as described above.
- Press and hold  for 3 seconds to turn on the automatic swing function to automatically move left and right. The horizontal deflector can be moved manually.
- Press and hold  again for 3 seconds to turn off the automatic swing function.

Switch the unit of temperature

When the appliance is running, hold down the " - " / " + " buttons together for 3 seconds at the same time. Then you can change the unit of temperature.

For example:

Before the change, in Cool mode, the screen displays like in

Fig. 13.



Fig.13

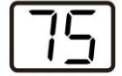

Fig.14



After the change, in Cool mode, the screen displays like Fig.

14.

SELF-DIAGNOSIS

The appliance has a self-diagnosis system to identify a number of malfunctions.

Error messages are displayed on the appliance display.

CODE DISPLAYED	WHAT SHOULD I DO?
 PROBE FAILURE (sensor damaged)	If this is displayed, contact your local authorized service center.
 High water level (safety tank full)	Empty the internal safety tank, following the instructions in the "End of season operations" paragraph.

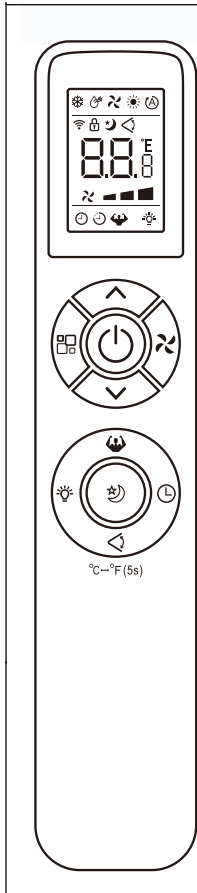

Display area icon

	Cooling mode		Fan speed
	Dry mode		Light
	Fan mode		Child lock
	Heating mode (ineffective)		Timer on
	Smart mode		Timer off
	Signal		Sleep
	Display digits temperature or hours		Turbo
	°C or °F temperature		Swing

Button icon

	On/Off button		Turbo button
	Increase button		Mode button
	Decrease button		Swing button
	Timer button		Sleep button
	Light button		Fan speed button

Remote Control

- ✓ Point the remote control at the receiver on the appliance.
- ✓ The remote control must be no more than 7 metres from the appliance (without obstacles between the remote and receiver).
- ✓ The remote control must be handled with extreme care. Do not drop it or expose it to direct sunlight or sources of heat.
- ✓ If the remote control does not work, please try to remove the battery and put it back again.

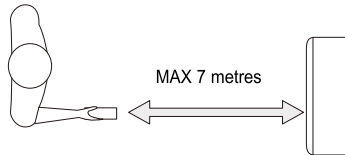

INSERTING OR REPLACING THE BATTERIES

- Remove the cover on the rear of the remote control;
- Insert two "AAA" 1.5V batteries in the correct position (see instructions inside the battery compartment);
- Put the cover back on the remote control.

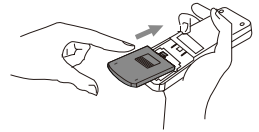





NOTE:

- ✓ If the remote control unit is replaced or disposed of, the batteries must be removed and discarded in accordance with current legislation, as they are harmful to the environment.
- ✓ Do not mix old and new batteries. Do not mix alkaline, standard (carbon-zinc) or rechargeable (nickel-cadmium) batteries.
- ✓ Do not dispose of batteries in a fire. Batteries may explode or leak.
- ✓ Remove the batteries if the remote control is not being used for an extended time.

COOL mode

Ideal for hot, muggy weather when you need to cool and dehumidify the room
To set this mode correctly:

- Press the  button a number of times until the  symbol appears.

- Select the target temperature 16°C-31°C (61°F -88°F) by pressing The  or  button until the corresponding value is displayed.
- Select the required fan speed by pressing the  button. Three speeds are available: High / Med / Low / Auto.



Low	Med	High	Auto
			Loop dynamic display



The most suitable temperature for the room during the summer varies from 24°C to 27°C (75°F to 81°F). You are recommended, however, not to set a temperature much below the outdoor temperature. The fan speed difference is more noticeable when the appliance is under Fan mode but may not be noticeable under Cool mode.

FAN mode

The air hose does not need to be attached when using the appliance in this mode.

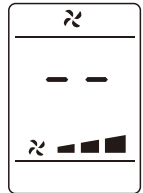

- Press the  button a number of times until the  symbol appears.
- Select the required fan speed by pressing the  button. Three speeds are available: High / Med / Low.



DRY mode



Ideal to reduce room humidity (Spring and Autumn, damp rooms, rainy periods, etc). In Dry mode, the appliance should be prepared the same as in Cool mode, with the air exhaust hose attached to enable the moisture to be discharged outside.

To set this mode correctly:

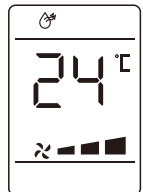
- Press the  button a number of times until the  symbol appears.
- In this mode, the appliance selects fan speed automatically and cannot be set manually.



Auto mode

- Press the  button several times until the  symbol appears.
- Select the required fan speed by pressing the  button.

Four speeds are available: High / Med / Low / Auto.

If the appliance is a cooling-only model, the unit operates in Fan mode when the room temperature is below 23°C (73°F) and Cool mode when the room temperature is above 25°C (77°F).

- Display on the control panel:

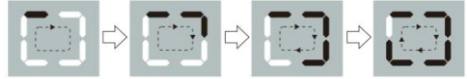

The display will be running circulating.





If the unit is a cooling and heating model, the unit operates in Heat mode when the room temperature is below 18°C (64°F) and Fan mode when the room temperature is from 20°C (68°F) to 23°C (73°F), and Cool mode when the room temperature is above 25°C (77°F).

SLEEP function

This function is useful for the night as it gradually reduces the operation of the appliance.

To set this function correctly:

- Select the Cool or Heat mode as described above.
- Press the  button, and the  symbol appears.
- When you choose the Sleep function, the screen will reduce the brightness, and the fan speed will be low.

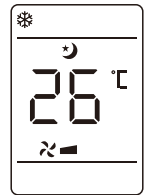

The SLEEP function maintains the room at optimum temperature without excessive fluctuations in either temperature or humidity with silent operation. Fan speed is always on Low, while room temperature and humidity vary gradually to ensure comfort.

When in Cool mode, the selected temperature will increase by 1°C (1°F) per hour in a 2-hour period. This new temperature will be maintained for the next 6 hours. Then, the appliance turns it off.



The SLEEP function can be canceled at any time during operation by pressing the "Sleep," "Mode," or "fan speed" button.

The SLEEP function is still available in Dry, Cool, and Heat mode.

SWING function

This function moves the deflectors to adjust the direction of the airflow.

To set this function correctly:

- Select the operating mode (Cool, Dry, Fan) as described above.
- Press the  button to select the horizontal deflector to automatically move left and right.
- Press the  button again to switch off this function.

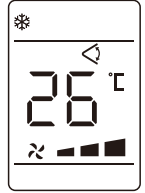

Switch the unit of temperature

When the appliance is running, hold down the  button, then you can change the unit of temperature.

For example:

Before the change, in Cool mode, the screen displays like

Fig. 15.



Fig.15



Fig.16











After the change, in Cool mode, the screen displays like Fig.

16.







SETTING THE TIMER







-This timer can be used to delay the appliance start-up or shutdown. This avoids wasting electricity by optimizing operating periods.

Programming start up

- Turn on the appliance and choose the mode you want, for example, Cool, 24°C, high fan speed. Turn off the appliance.
- Press the  button twice; the screen will display hours, and the  symbol and  symbol are flashing.
- Press the  or  button until the corresponding time is displayed.
- Press the  button again; the timer will be active, and the  symbol and  will be displayed on the screen.
- Press the  button again or the  button; the timer will be canceled, and the  symbol will disappear from the screen.



Programming shut down

- When the appliance is running, press the  button, and the screen will display hours, and the   symbol and  symbol are flashing.
- Press the  or  button until the corresponding time is displayed.







-
- Press the  button again. The timer will be active, and the  symbol and  are displayed on the screen.
 - Press the  button again or the  button; the timer will be canceled, and the  symbol will disappear from the screen.

CHILD LOCK function

This function is used to prevent children from pressing the remote controller carelessly or accidentally.

- Hold down the  and  together for more than 5 seconds to open or cancel the child lock function.
- When the CHILD LOCK icon is on, pressing any button on the remote control will be invalid.

Turbo function

- Press the  button, and the  symbol flash on the screen
- This function sets the appliance directly to Cool mode with a setting temperature of 16°C (61°F) and High fan speed in order to reach low temperature in the shortest time.
- This function cannot be set in Heat mode.
- To cancel this function, press the ; the  will stop flashing and disappear from the screen.
- Pressing other buttons like "  " or "  " or "  " can also cancel this function.

LIGHT function

This function is applicable to sleep at night.

When the machine is running, you can press the "  " button, and all the display lights will be turned off. When pressed again, all display lights will resume.

TIPS FOR CORRECT USE

To get the best from your appliance, follow these recommendations:

- Close the windows and doors in the room to be air-conditioned (Fig. 17). When installing the appliance semi-permanently, you should leave a door slightly open (as little as 1 cm) to guarantee correct ventilation;

- Protect the room from direct exposure to the sun by partially closing curtains and/or blinds to make the appliance much more economical to run (Fig. 18);
- Never place objects of any kind on the appliance;
- Do not block the air inlet or outlet of the appliance. Reduced airflow will result in poor performance and could damage the unit (Fig. 19).
- Make sure there are no heat sources in the room;
- Never use the appliance in damp rooms (for example, the laundry room).
- Never use the appliance outdoors.
- Make sure the appliance is standing on a level surface. If necessary, place the castor locks under the front wheels.

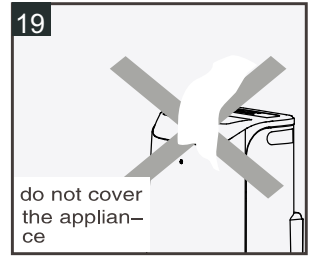
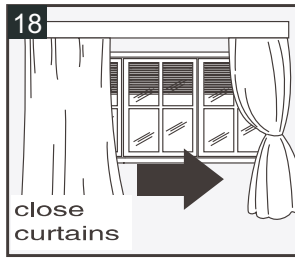
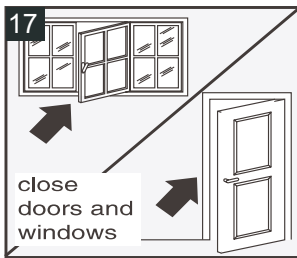

WATER DRAINAGE METHOD

When excess water condensation is inside the unit, the appliance stops running and shows "HL" (High water level). This indicates that the water condensation needs to be drained using the following procedures:

Manual Draining (Fig.20)

Water may need to be drained in high-humidity areas

1. Unplug the unit from the power source.
2. Place a drain pan under the lower drain plug. See diagram.
3. Remove the lower drain plug.
4. Water will drain out and collect in the drain pan (not supplied).
5. After the water is drained, replace the lower drain plug firmly.
6. Turn on the unit.

Continuous Draining (Fig.21)

Continuous drainage is recommended when using the unit in Dry mode.

1. Unplug the unit from the power source.
2. Remove the drain plug. While doing this operation, some residual water may spill, so please have a pan to collect the water.

3. Connect the drain hose (1/2" or 12.7mm, may not be supplied). See diagram.
4. The water can be continuously drained into a floor drain or bucket through the hose.
5. Turn on the unit.

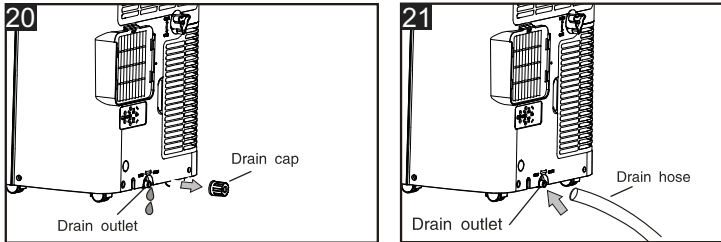

NOTE

Please be sure that the height of any section of the drain hose is not higher than that of the drain outlet, or the water tank may not be drained. (Fig.22 and Fig.23)

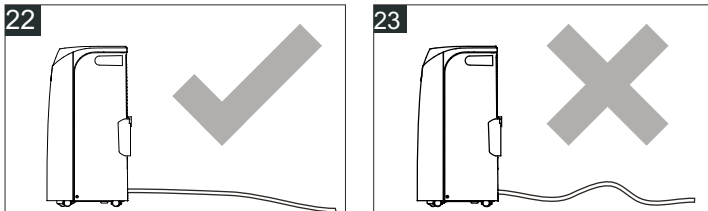

Middle drainage

When the unit running in Dry mode, you can choose the way below to drain.

1. Unplug the unit from the power source.
2. Remove the drain plug (Fig A). While doing this operation, some residual water may spill, so please have a pan to collect the water.
3. Connect the drain hose (1/2" or 12.7mm, may not be supplied). (Fig B)
4. The water can be continuously drained into a floor drain or bucket through the hose.
5. Turn on the unit.

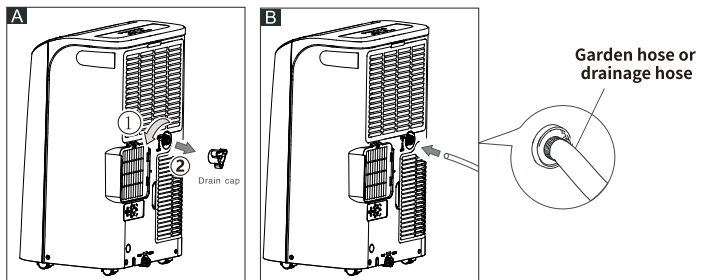

NOTE: Please be sure that the height of any section of the drain hose is not higher than that of the drain outlet, or the water tank may not be drained. (Fig.24 and Fig.25)

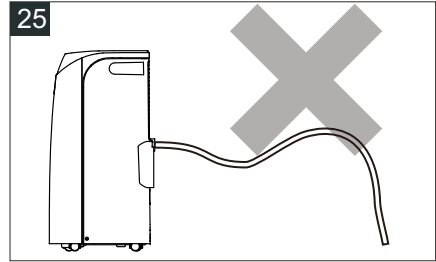
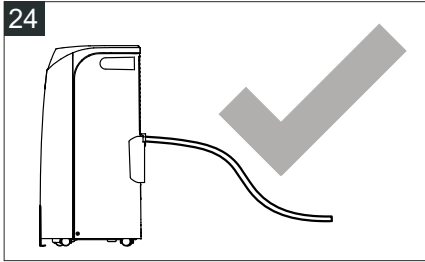

CLEANING

Before cleaning or maintenance, turn the appliance off by pressing the  button on the control panel or remote control. Wait for a few minutes, then unplug from the main socket.

CLEANING THE CABINET

You should clean the appliance with a slightly damp cloth and then dry it with a dry cloth.

- Never wash the appliance with water. It could be dangerous.
- Never use petrol, alcohol, or solvents to clean the appliance.
- Never spray insecticide liquids or similar.

CLEANING THE AIR FILTERS

To keep your appliance working efficiently, you should clean the filter every month of operation.

The filter can be taken out, as shown in Fig. 26.

To avoid possible cuts, avoid contacting the metal parts of the appliance when removing or reinstalling the filter. Contact with these parts can result in personal injury.

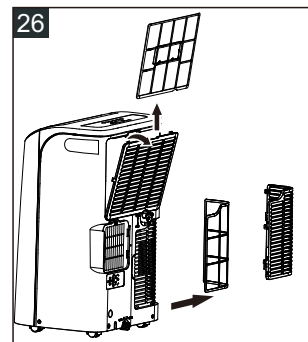

Use a vacuum cleaner to remove dust accumulations from the filter. If it is very dirty, immerse it in warm water and rinse it several times. The water should never

be hotter than 40°C(104°F). After cleaning the filter, leave the filter out to dry before reinstalling it

START-END-OF-SEASON OPERATIONS

START OF SEASON CHECKS

Ensure the power cable and plug are undamaged, and the earth wiring system is intact.

Follow the installation instructions precisely.

END-OF-SEASON OPERATIONS

To empty the internal circuit entirely of water, remove the cap. (Fig.27)

Drain off all water left into a basin. Put the cap back in place when all the water has been drained.

Clean the filter and dry it thoroughly before putting it back.

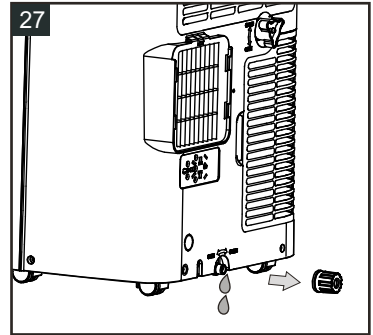

Strictest operation environment:

Cooling mode: 18°C-35°C (64°F-95°F)

SKU	PAC004-12KWG	PAC004-14KWG
Wattage (ASHRAE)	12000BTU	14000BTU
Voltage	115V/60HZ	115V/60HZ
Net Weight	56.7lbs	65lbs
Dimensions	16.5(L)x14(W)x27(H) in	16.5(L)x14(W)x27(H) in

TROUBLESHOOTING

PROBLEM	CAUSE	SOLUTION
The appliance does not come on	<ul style="list-style-type: none"> • There is no current • It is not plugged into the main. • The internal safety device has tripped. 	<ul style="list-style-type: none"> • Wait • Plug into the main • Wait 30 minutes. If the problem persists, contact your service center.
The appliance works for a short time only	<ul style="list-style-type: none"> • There are bends in the air exhaust hose • Something is preventing the air from being discharged 	<ul style="list-style-type: none"> • Position the air exhaust hose correctly, keeping it as short and free of curves as possible to avoid bottlenecks. • Check and remove any obstacles obstructing air discharge
The appliance works but does not cool the room	<ul style="list-style-type: none"> • Windows, doors, and/or curtains are open 	<ul style="list-style-type: none"> • Close doors, windows, and curtains, bearing in mind the "tips for correct use" given above
	<ul style="list-style-type: none"> • There are heat sources in the room (oven, hairdryer, etc.) 	<ul style="list-style-type: none"> • Eliminate the heat sources
	<ul style="list-style-type: none"> • The air exhaust hose is detached from the appliance 	<ul style="list-style-type: none"> • Fit the air exhaust hose in the housing at the back of the appliance
	<ul style="list-style-type: none"> • The technical specification of the appliance is not adequate for the room in which it is located 	<ul style="list-style-type: none"> • Move the air conditioner to a suitable room
During operation, there is an unpleasant smell in the room	<ul style="list-style-type: none"> • Air filter clogged 	<ul style="list-style-type: none"> • Clean the filter as described above
The appliance does not operate for about three minutes after restarting it	<ul style="list-style-type: none"> • The internal compressor safety device prevents the appliance from being restarted until three minutes have elapsed since it was last turned off 	<ul style="list-style-type: none"> • Wait. This delay is part of normal operation
The following message appears on the display: HL / E1 / E2	<ul style="list-style-type: none"> • The appliance has a self-diagnosis system to identify a number of malfunctions 	<ul style="list-style-type: none"> • See the SELF-DIAGNOSIS Chapter

