

Countertop Dishwasher

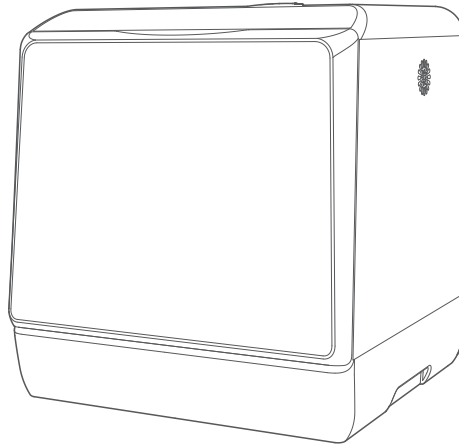

SKU : ZX-DW-01

Please read the manual carefully. It contains important information on how to install, use and maintain the machine. Please retain all documents for subsequent use or for next owner.

CONGRATULATIONS

Dear Customer:

Welcome to our family. Thank you for purchasing one of our products.

Our goal is to provide you with superior service. If there is anything missing from or wrong with your order, or if you have any questions about using our ice maker, PLEASE contact us.

Email: support@homyd.com

Team is available 24/7 to address your questions, comments, and concerns. Your satisfaction is our ultimate goal. We want to make everything right so you'll share your positive experience with other shoppers

If you experience any problems, please send an email to support@homyd.com

Our mission:

- * To be the most trusted appliance brand.
- * To create practical, compact appliances that better your life.

LIST

How to use

Product Introduction	01
Control Panel	02
Installation	03
Tableware Loading	04
Operation	05
Function	07

Maintain and repair

Maintain & Clean	08
Fault & problem	09
Specification	13
RoHs Requirement	14
Safety & Warning	15
Importan Safety Instructions	16

Product Introduction

Machine

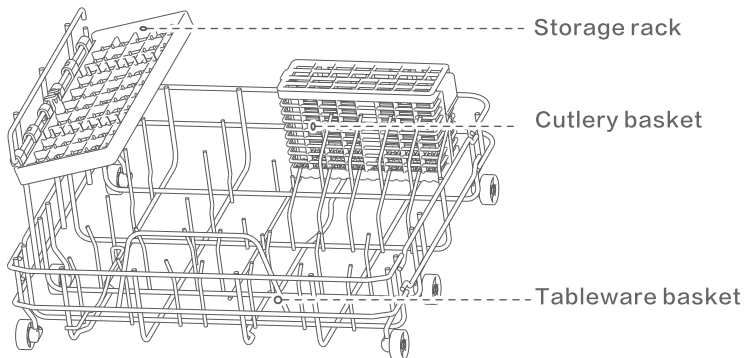
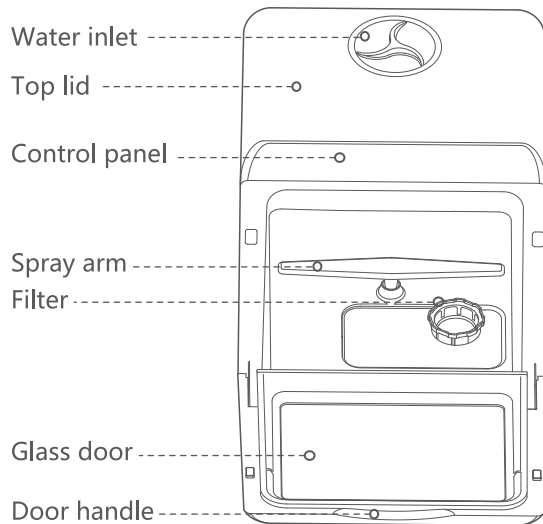

Parts list

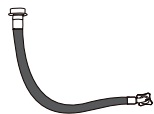

Inlet hose x1

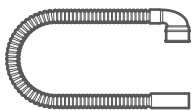

Drain hose x1

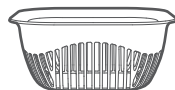

Fruit basket x1



Cup x1



Hose collar x1

Control Panel

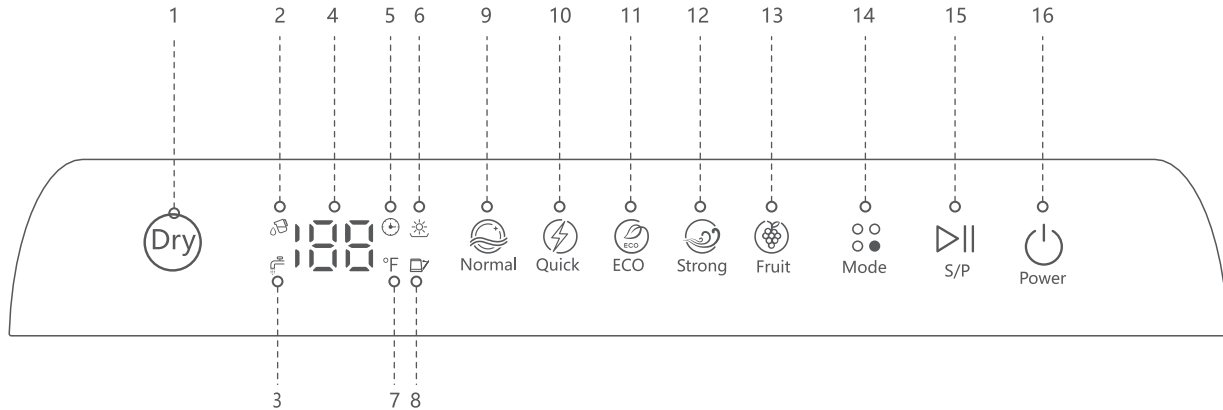

1.Dry
2.Tank model
3.Tap model
4.Display screen

5.Time display
6.Dry indicator
7.Temperature
8.Door open

9.Normal
10.Quick
11.ECO
12.Strong

13.Fruit
14.Program option
15.Start/Pause
16.Power on/off

Installation

1. Inlet hose installation

① connect machine

Insert inlet hose elbow into the water inlet behind machine and tighten the screw.

② connect tap

A、B、C three options for tap connection, but B and C options need make a hole on or behind cabinet in order the hose can go through cabinet.

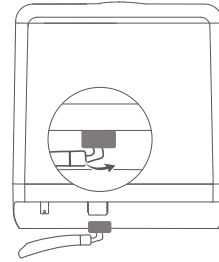

connect machine

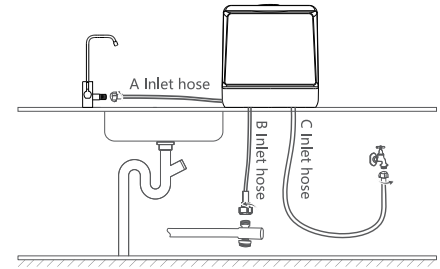

connect tap

NOTE: We offer 59 inch standard 3/4" GHT-11 hose connectors.

2. Drain hose installation

① Connect machine

Insert drain hose elbow to the water outlet behind machine and tighten the collar.

② Connect sewer

A、B、C three options for sewer connection, B and C options need make a hole on or under cabinet in order the hose can go through cabinet.

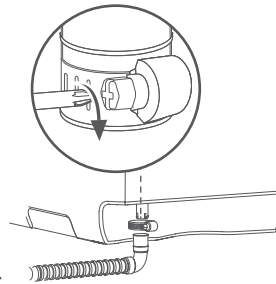

connect machine

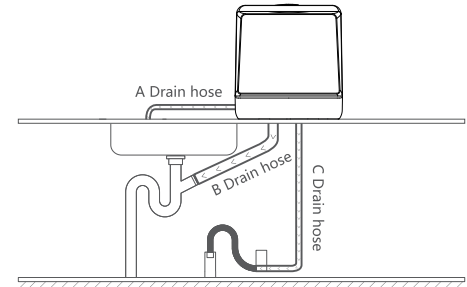

connect sewer

Note: A hose that attaches to a sink spray can burst if it is installed on the same water line as the dishwasher. If your sink has one, it is recommended that the hose be disconnected and the hole plugged.

Tableware Loading

- 1 Please get rid of large food residue on tableware, avoiding to block water hose.

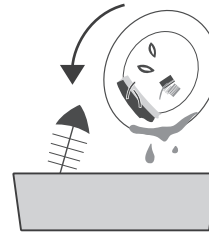

- 2 Please make reference to right pictures for tableware display.

Note:

In order to fully clean tableware, please tilt tableware internally or put stained face down.

Tableware	Quantity
190mm Dessert plate	3
130mm Dessert bowl	1
70mm Mug	1
60mm Glass	2
Fork	2
Knife	2
Soup spoon	2
Dessert spoon	2
Tea spoon	2
230mm Soup plate	1
140mm Saucer	1
78mm Cup	1
213mm Melamine bowl	1
Serving Fork	1
195mm Melamine dessert plate	1

Cleaning Program:ECO

Under ECO washing program, add 16g detergent, then start washing. When 18 minutes left before washing finish, pause washing, open the door and add 2ml rinse aid, then close the door to continue the washing till the washing finishes

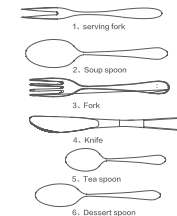
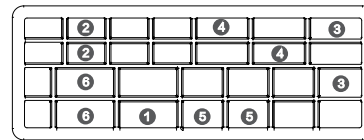
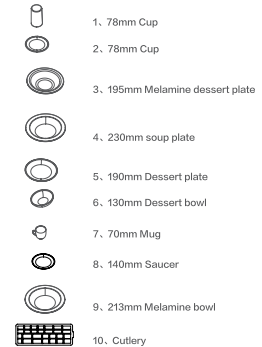
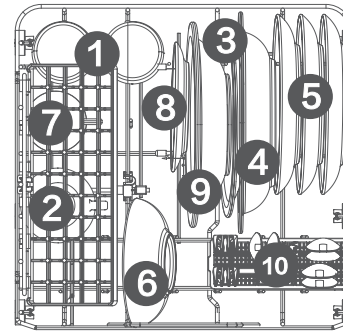

Operation

1 Power on

Plug in, touch "  ", turn on the machine.

Note:

During washing program running, touch "  " for 3 seconds to force the machine to turn off.

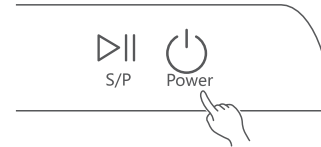

2 Add detergent

Open the door, add moderate detergent powder, or 1pc detergent block into the machine, close the door.

Note:

No detergent when fruit washing;
The dosage: 8-10g for each washing circle.

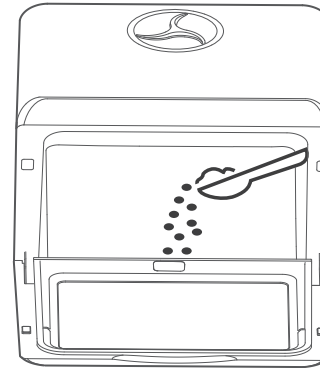

3 Program selection

Touch "  ", each of program indicator will light one by one, select the program you want.



Operation

4 Run program

Touch "▶||" ^{S/P}, run selected program, the machine will check water supply automatically.



Note:

- ① Check tap or tank model automatically after running program, if the indicators "☹" "☹" "☹" become red, you need open tap or fill tank with water;
- ② After 5 times checking, there is still no water supply, the machine will enter standby;
- ③ Touch "▶||" ^{S/P} to force to pause machine to add tableware during washing;
- ④ Touch "⏻" for 3 seconds to quit program, the machine will drain, then turn off;
- ⑤ Touch "⏻" to add 73 hours' circular wind to keep air fresh inside machine.

5 Wash

The machine has two water supply models, tap model and tank model.

Note:

- ① The indicator "☹" is white, means tank model;
- ② The indicator "☹" is white, means tap model;
- ③ If tank is full, the machine will switch into tank model automatically;
- ④ Fill 3 cups of water into tank, Di,Di,Di will be sound if tank is full, the indicator "☹" will become white;
- ⑤ If tap model, please open water tap.

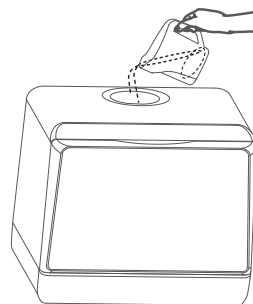

Fill water by hand
(For tank model)

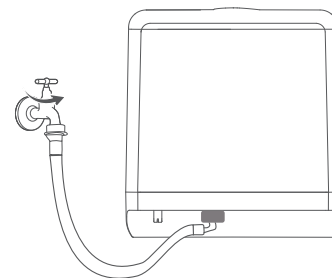

Connet tap
(For tap model)

Function

Program	Program execution	Time	Detergent	Temperature	Drying time	Storage (if selected)
Normal	Hot water washing Cold water rinsing Cold water rinsing Hot water rinsing	69Min	8g	Washing 55°C(131°F) Rinsing 68°C(154°F)	60Min	Circulating fresh air 73 hours
Quick	Hot water washing Cold water rinsing Hot water rinsing	29Min	8g	Washing 50°C(122°F) Rinsing 62°C(144°F)	60Min	Circulating fresh air 73 hours
Strong	Hot water washing Hot water rinsing Cold water rinsing Hot water rinsing	89Min	12g	Washing 55°C(131°F) Rinsing 55°C(131°F) Rinssing 75°C(167°F)	60Min	Circulating fresh air 73 hours
ECO	Hot water washing Cold water rinsing Hot water rinsing	59Min	8g	Washing 55°C(131°F) Rinsing 68°C(154°F)	60Min	Circulating fresh air 73 hours
Fruit	Cold water rinsing Cold water rinsing	19Min	/	/	/	/
Dry	/	/	/	/	60Min	Circulating fresh air 73 hours

Note: It is normal that the machine may pause for a few minutes during working.

Maintain & Clean

1. Clean Filter

① Disassemble.

Rotate anticlockwise to disassemble the filter set, Which have 3 parts, filter mesh, main filter and fine filter.

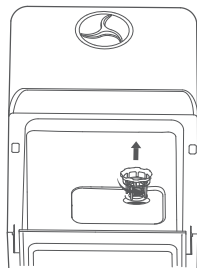

② Clean

Use water to flush and brush each of filter parts



③ Assemble

After cleaning, rotated clockwise to close the filter set.

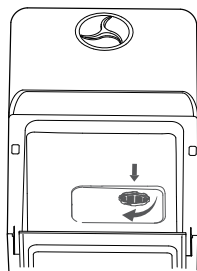

2. Clean spray arms

① Disassemble

Open the door, take out the basket, then pull out up and down spray arm

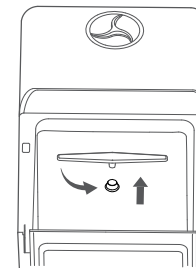

② Clean

Use water to flush and brush each spray arm, use tools with sharp point, like needle to clean holes if needed.

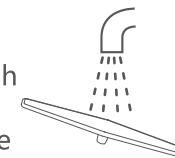

③ Assemble

After cleaning, please press each arms into positions, make sure the arms can move smoothly.

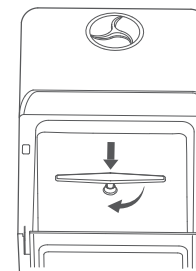

NOTE: If there is limescale in the tank, it is recommended that you clean it with vinegar or citric acid.

Fault & problem

1.Fault codes

Code	Fault	How to deal with
"E2"	Draining	1.Check drain pipe, be sure the pipe is straight, no bending; 2.Power off, check if anything block filter or drain pipe; 3.Be sure all pipes are not blocked by something.
"E3"	Overflowing	Tilt the machine to 30~45 degree, let water flow out from base of machine, then restart machine, if still fault, contact our serviceman.
"E4"	Temperature	Restart machine, if still fault, please contact our serviceman.
"E5"	Message	
"E6"	Heating	
"E7"	Pressure	

Fault & problem

2.Problem(1)

Problem	Reason	How to deal with
Tableware is not clean	Incorrect tableware loading	be sure enough gap between tableware.
	spray arm trapped	Be sure nothing trap the spray arm.
	Blocked spray arm	Clean spray arm.
	Blocked filter	Clean filter set.
	Incorrect filter installation	Correctly assamble filter set.
	Incorrect program selection	Select appropriate washing program.
	No detergent	Add detergent (block/powder/liquid).
Don' t start the machine	Water shortage	Add water till the indictator light off.
	Door do not close fully	Check the door if anything stop closing fully.
Can not select program	Be washing	Re-select program after stop in-progress program or wait in-progress program finishing .

Fault & problem

2.Problem(2)

Problem	Reason	How to deal with
Tableware is not dry	Inappropriate program	Select appropriate program
	Poor dry effect for plastic tableware	Wipe to dry these plastic tableware by hand
	Incorrect tableware loading	Correct tableware setting in accordance
	Drying program no finishing	Wait the dry program finishing
	Wooden tableware	Wipe to dry these wooden tableware by hand
Discoloration of plastic tableware	Over high washing temperature	Select program with lower temperature
Detergent left	Trapped spray arm, no water flush detergent	Be sure spray arm move smoothly
	Detergent with poor quality	Use qualified detergent

Fault & Problem

2.Problem(3)

Problem	Reason	How deal with
A mount of foam in the machine	Use incorrect detergent	1.Use special detergent for dishwasher; 2.Open machine, wipe out foam by hand; 3.Fill 2-3L water into machine, select any program, after 1-2 min, the foam will be drained, can repeat the process if needed.
Abnormal sound in the machine	Spray arm knock tableware	Correctly loading the tableware
	Tableware move slightly	Fix tableware before washing
Egg custard left on the tableware	Portein solidification	wash the tableware with egg custard by hand
Water drops left inside of machine	Drying time is not enough	Selet "Dry" program

Specification

Machine

SKU	ZX-DW-01
Voltage	120V~
Hz	60Hz
Power	950W
Inlet pressure	0.03~1MPa
Water consumption	5L
Place setting	4sets
Net weight	13kg
Machine size (WxDxH)	428×425×458(mm)
Dry	Hot wind

Electrical Drawing

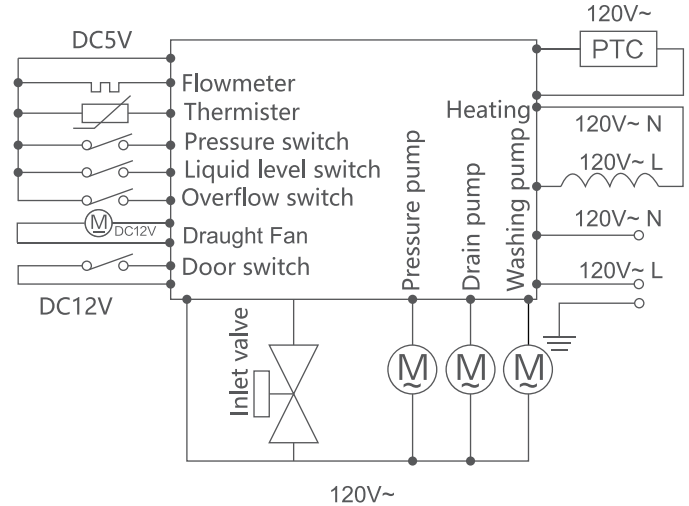

RoHS Requirement

Hazardous substances content						
Components	substances					
	P b	Hg	Cd	Cr6+	PBB	PBDE
Plastic parts	O	O	O	O	O	O
Metal parts	O	O	O	O	O	O
Rubber parts	O	O	O	O	O	O
Screws	O	O	O	O	O	O
Stickers	O	O	O	O	O	O
Heat plate	O	O	O	O	O	O
Wire	O	O	O	O	O	O
Water pumps	O	O	O	O	O	O
PCB ,Fan	X	O	O	O	O	O
Water valve	O	O	O	O	O	O
Parts of others	O	O	O	O	O	X

The table is made according to SJ/T11364 standards.

O: indicates the hazardous substance contain is below the limitation of GB/T26572 standards.

X: indicates the hazardous substance contain is over the limitation of GB/T26572 standards, but fit for the RoHS order.

The information of the table is offered by suppliers, under the present skills, we will keep the lowest level of hazardous substance in all of machine parts. We promise that we will try our best to low the level of hazardous substance in the machine through improving the technologies constantly

Safety and warning

Warning

1. Power socket must be grounded,avoiding to possible electric leakage or shock;
2. Don't share one socket with other appliance avoiding to avoid fire;
3. Any of new parts or power line will be changed by service man after damages;
4. Dispose of the machine in a environmentally friendly manner under local regulations;
5. Do not place the machine in the environment under 32°F , like outside door in cold weather;
6. Please use the salt and detergent which is special for dishwasher;
7. Don't place and use the machine in the platform which is not stable,wet,smooth,inflammable avoiding to any damage;
8. Don't place and use the machine within 150mm far from gas stoven or heater;
9. Don't place any heavy object on the door when door open avoiding to the machine turn over;
10. Don't splash water into the machine to electric shock or fire;
11. Don't drink the water in the machine;
12. Don't let children operate the machine independently avoiding to any dangerousness.

Precaution

- 1.Don't open the door when washing avoiding hot water flying out causing any hurts;
- 2.Don't touch or block the side air outlet;
- 3.Don't tilt or move the machine when washing;
- 4.Don't face person avoiding to any hurts when open door;
- 5.Please stop washing, power off, and close tap when any fault occur;
- 6.Please check and clean the machine time by time in order to the best washing effect;
- 7.Please fix the drain hose avoiding to the stained water outflow;
- 8.Don't forcely pull power cord, drain hose, press cutlery tray avoiding any damage;
- 9.Don't use wet hand to operate the machine avoiding electric shock;
- 10.Children shoud be far away from the chemical material such as salt, detergent avoiding to any hurt.

IMPORTANT SAFETY INSTRUCTIONS

Use only detergents or wetting agents recommended for use in a dishwasher and keep them out of the reach of children.

When loading items to be washed:

- 1) Locate sharp items so that they are not likely to damage the door seal; and
- 2) Load sharp knives with the handles up to reduce the risk of cut-type injuries.

Do not wash plastic items unless they are marked "dishwasher safe" or the equivalent. For plastic items not so marked, check the manufacturer's recommendations.

Do not touch the heating element during or immediately after use.

Do not operate your dishwasher unless all enclosure panels are properly in place.

Do not tamper with controls.

Do not abuse, sit on, or stand on the door or dish rack of the dishwasher.

To reduce the risk of injury, do not allow children to play in or on a dishwasher.

Under certain conditions, hydrogen gas might be produced in a hot-water system that has not been used for two weeks or more.

HYDROGEN GAS IS EXPLOSIVE. If the hot-water system has not been used for such a period, before using the dishwasher turn on all hot-water faucets and let the water flow from each for several minutes. This will release any accumulated hydrogen gas.

As the gas is flammable, do not smoke or use an open flame during this time.

Remove the door to the washing compartment when removing an old dishwasher from service or discarding it.

GROUNDING INSTRUCTIONS

This appliance must be grounded. In the event of a malfunction or breakdown, grounding will reduce the risk of electric shock by providing a path of least resistance for electric current. This appliance is equipped with a cord having an equipment-grounding conductor and a grounding plug. The plug must be plugged into an appropriate outlet that is installed and grounded in accordance with all local codes and ordinances.

WARNING – Improper connection of the equipment-grounding conductor can result in a risk of electric shock. Check with a qualified electrician or service representative if you are in doubt whether the appliance is properly grounded. Do not modify the plug provided with the appliance, if it will not fit the outlet, have a proper outlet installed by a qualified electrician.

WARRANTY AND SERVICE

This product is covered by a 12-month product and warranty from the date of initial purchase in case of any problems, please contact the Customer Service Center via the contact information listed in this User Guide.

Our warranty covers replacement products by repairing or replacing any defective parts and labor necessary to bring it up to its original specifications, and we can provide a replacement product instead of repairing the defective product. Our sole obligation under this warranty is limited to such repair or replacement.

Any claim will require a receipt showing the date of purchase, so please keep all receipts in a safe place.

While greatly appreciated, product registrant is not required to activate any warranty and product registration does not eliminate the need for proof of original purchase. The warranty will be voided if repairs are performed by a non-authorized third party and/or if spare parts other than those provided by us are used. These are the general terms of our warranty service, but we always urge our customers to contact us

(support@homyd.com) with any questions they may have, regardless of the terms of the warranty.